

Installation Manual



G3.5

Direct Vent Insert
Gas Fireplace
natural gas 700RN
propane gas 700RP

with
AutoFire™

Canadian Patent 2,717,779 Issued October 24 2017
US Patent 10,060,624 Issued August 28 2018
US Patent 10,935,246 Issued March 2 2021

Installer: Place model/serial number here.

Installer: Leave this manual with the appliance.
Consumer: Retain this manual for future reference.

⚠ WARNING:
FIRE OR EXPLOSION HAZARD
Failure to follow safety warnings exactly could result in serious injury, death, or property damage.

Do not store or use gasoline or other flammable vapors and liquids in the vicinity of this or any other appliance.

WHAT TO DO IF YOU SMELL GAS

- Do not try to light any appliance.

- Do not touch any electrical switch; do not use any phone in your building.
- Leave the building immediately.
- Immediately call your gas supplier from a neighbor's phone. Follow the gas supplier's instructions.
- If you cannot reach your gas supplier, call the fire department.

Installation and service must be performed by a qualified installer, service agency or the gas supplier.

⚠ DANGER



Hot glass will cause burns.
Do not touch glass until cooled.
Never allow children to touch glass.

A barrier designed to reduce the risk of burns from the hot viewing glass is provided with this appliance and must be installed for the protection of children and other at-risk individuals.

This appliance may be installed in an after-market permanently located, manufactured (mobile) home where not prohibited by local codes. This appliance is only for use with the type of gas indicated on the rating plate. This appliance is not convertible for use with other gases, unless a certified kit is used.

INSTALLER: Leave this manual with the appliance.
CONSUMER: Retain this manual for future reference.

Massachusetts:

The piping and final gas connection must be performed by a licensed plumber or gas fitter in the State of Massachusetts. Also, see Carbon Monoxide Detector requirements in this manual, page 38.

⚠ WARNING

This product can expose you to chemicals including Benzene, which is known to the State of California to cause cancer and birth defects or other reproductive harm. For more information go to www.P65Warnings.ca.gov.

Note: Natural gas, in its original state, contains Benzene.

This manual contains instructions to install the **ENGINE ONLY**. A trim kit is **REQUIRED** to complete the installation. A barrier screen is provided with the trim kit. **Refer to the manual supplied with the trim for installation.**

This appliance is a domestic room-heating appliance. It must not be used for any other purposes such as drying clothes, etc.

This appliance is suitable for installation in a bedroom or bed sitting room.

Ce guide est disponible en français sur demande.



We recommend a US Certified National Fireplace Institute (NFI) specialist install our gas hearth products.



The information contained in this manual is believed to be correct at the time of printing. Miles Industries Ltd. reserves the right to change or modify any information or specifications without notice. Miles Industries Ltd. grants no warranty, implied or stated, for the installation or maintenance of your heater, and assumes no responsibility for any consequential damage(s).

© Copyright Miles Industries Ltd., 2026. All rights reserved.
Designed and manufactured for Miles Industries Ltd.

Welcome to Valor®

This appliance has been professionally installed by:

Dealer Name: _____

Phone: _____

Please read this manual BEFORE installing and operating this appliance.

Fireplace Safety	4
Specifications	6
Kits & Accessories.....	7
Approved Venting Components	8
Dimensions & Cavity	9
Clearances	10
Installation Planning	12
Before Installation	12
Overview	13
Venting	14
Preparation	16
Existing Fireplace Preparation.....	16
Installation	17
Window and Optional Fan	17
Venting.....	18
Gas Supply.....	19
Liners	21
Fuel Beds	23
Birch Log Kit 700BLK.....	23
Traditional Log Kit 700LSK	26
Driftwood Log Kit 700DWK	29
Window Re-Installation & Checking	32
Remote Control Pairing.....	33
Check Operation and Aeration.....	34
Front Trim.....	35
Remote Control Holder.....	36
GV60 Wiring Diagram	37
Commonwealth of Massachusetts	38
Appendix A—Lighting Instructions.....	39
Appendix B—Remote Control Operation	40
Appendix C—Spare Parts	47

Fireplace Safety

This manual contains very important information about the safe installation and operation of the fireplace. Read and understand all instructions carefully before installing and operating the fireplace. Failure to follow these instructions may result in possible fire hazard and will void the warranty.

Replacement manuals are available by contacting the Valor Customer Service at 1-800-468-2567, or by visiting valorfireplaces.com.

WARNING: Extremely Hot!

Heat and flammability

- Some parts of the fireplace are extremely hot, particularly the glass window. Use the barrier screen provided or a gate to reduce the risk of severe burns.
- The glass windows can exceed 500°F at full capacity.
- Always keep the appliance clear and free from combustible materials, gasoline, and other flammable vapors and liquids.
- Be aware of hot wall surfaces! The wall directly above the fireplace can get very hot when the fireplace heats. Although safe, it may reach temperatures in excess of 200°F (93°C) depending on choice of optional accessories. Do not touch!
- Be aware of hot shelf/hearth/floor surfaces! Any projections directly around the fireplace can get very hot when the fireplace heats. Although safe, they may reach temperatures in excess of 200°F (93°C) depending on their elevation. Be careful of touching these! Do not put objects on the hearth or shelf. Temperature of projection surfaces will be reduced when barrier screen is installed.
- Some materials or items, although safe, may discolor, shrink, warp, crack, peel, and so on because of the heat produced by the fireplace. Avoid placing candles, paintings, photos and other combustible objects sensitive to heat or furniture within 36 inches (0.9 m) around the fireplace.
- Solid wood flooring in front of the fireplace (if allowed) may shrink during the heating season due to heat.
- Due to high temperatures, the appliance should be located out of traffic areas and away from furniture and draperies.
- Clothing or other flammable material should not be placed on or near the appliance.

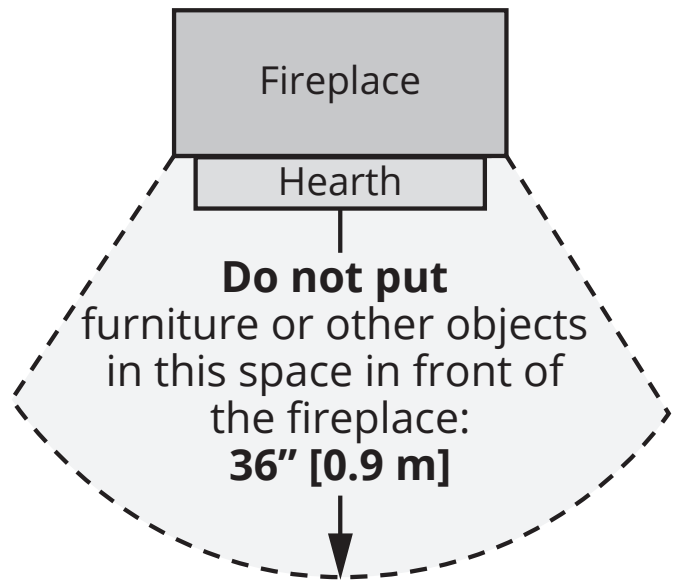

Barrier Screen and Safety

- A barrier designed to reduce the risk of burns from the hot viewing glass is provided with this appliance and must be installed for the protection of children and other at-risk individuals.
- Children and adults should be alerted to the hazards of high surface temperature and should stay away to avoid burns or clothing ignition.
- Young children should be carefully supervised when they are in the same room as the appliance. Toddlers, young children, and others may be susceptible to accidental contact burns. A physical barrier is recommended if there are at-risk individuals in the house. To restrict access to a fireplace or stove, install an adjustable safety gate to keep toddlers, young children, and other at-risk individuals out of the room and away from hot surfaces.
- Any safety screen, guard, or barrier removed for servicing an appliance, must be replaced prior to operating the appliance.

Fireplace Safety

Glass window

WARNING

Do not operate this appliance with the glass front removed, cracked, or broken.

Do not strike or slam the glass front.

Replacement of the glass front should be performed by a licensed or qualified service person.

- The glass front assembly must be in place and sealed before the unit can be placed into safe operation.
- The glass front assembly must only be replaced as a complete unit, as supplied by the fireplace manufacturer. No substitute material may be used.
- Do not use abrasive cleaners on the glass front assembly. Do not attempt to clean the glass when it is hot.

Venting

- This unit must be used with a vent system as described in this manual. No other vent system or components may be used.
- Never obstruct the flow of combustion and ventilation air. Keep the front of the appliance clear of all obstacles and materials for servicing and proper operation.
- This gas fireplace and vent assembly must be vented directly to the outside and must never be attached to a chimney serving a separate solid fuel burning appliance. Each gas appliance must use a separate vent system. Common vent systems are prohibited.

Intended use

- This appliance is designed and approved as a supplemental heater and provides the potential for most energy conservation when used while attended. The use of an alternate primary heat source is advisable.
- This unit is not for use with solid fuel.
- Do not use this heater as a temporary source of heat during construction.

Installation and Servicing

- Installation and repair should be done by a qualified service person. The appliance should be inspected before use and at least annually by a professional service person. More frequent cleaning might be required due to excessive lint from carpeting, bedding material, et cetera. It is imperative that control compartments, burners, and circulating air passageways of the appliance be kept clean.
- Do not use this appliance if any part has been under water. Immediately call a qualified service technician to inspect the appliance and to replace any part of the control system and any gas control that has been under water.

Specifications

Approval & Codes

This appliance is certified to ANSI Z21.88/CSA 2.33 American National Standard / CSA Standard for Vented Gas Fireplace Heaters for use in Canada and USA, and to CGA 2.17-91 High Altitude Standard in Canada. This appliance is for direct vent installations.

This appliance complies with CSA P.4.1-15 Testing method for measuring annual fireplace efficiencies.

The installation must conform to local codes or, in the absence of local codes, with the National Fuel Gas Code, ANSI Z223.1/NFPA 54 or the Natural Gas and Propane Installation Code CAN/CGA-B149.1. Only qualified licensed or trained personnel should install this appliance.

This appliance must be electrically grounded in accordance with local codes, or, in the absence of local codes, with the National Electrical Code, ANSI/NFPA 70 or the Canadian Electrical Code, CSA C22.1.

Ratings

Model	700RN	700RP
Gas	Natural	Propane
Altitude (Ft.)*	0-4,500 feet*	
Input Maximum (Btu/h)	26,000	26,000
Input Minimum (Btu/h)	13,000	11,000
Manifold Pressure (in w.c.)	3.5"	10"
Minimum Supply Pressure (in w.c.)	5"	11"
Maximum Supply Pressure (in w.c.)	10"	14"
Main Burner Injector Marking	750	260
Pilot Injector Marking	51	30
Min. Rate Bypass Screw	175	105

*High Altitude Installations

Input ratings are shown in BTU per hour and are certified without deration for elevations up to 4,500 feet (1,370 m) above sea level.

For elevations above 4,500 feet (1,370 m) in USA, installations must be in accordance with the current ANSI Z223.1 and/or local codes having jurisdiction. Heating value of gas in some areas is reduced to compensate for elevation—consult your local gas utility to confirm.

For installations at elevations above 4,500 feet (1,370 m) in Canada, please consult provincial and/or local authorities having jurisdiction.

Supply Gas

Heater engine 700RN uses natural gas.

Heater engine 700RP uses propane gas.

The supply pressure must be between the limits shown in the *Ratings* section.

The supply connection is 1/2" NPT female and located on the left side of the control valve. The gas line entry point is on the the upper left hand side of the fireplace. See *Gas Supply Installation* section for details.

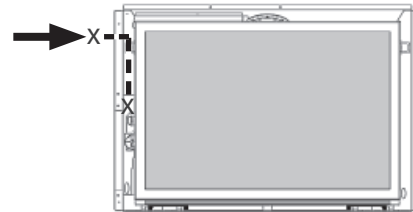

Electrical

The 700R is designed to run on battery power and does not require an electrical source to operate as a heater. However, if the appliance is fitted with a fan, a grounded power source is required.

Gas Conversion Kits

The 700R is supplied as natural gas or propane gas and is field convertible between fuels. See instructions packaged with the conversion kits for further information.

Floor/Hearth

This appliance is approved for installation into existing solid-fuel burning fireplaces only. Combustible material such as plywood and so on may be used for leveling and shimming beneath the unit. This appliance does not require a hearth other than to support the weight of certain fronts.

Outdoor Conversion Kit

The 700R models are supplied standard for indoor applications and may be adapted for installation in specific "outdoor" applications protected from weather as defined in the GV60CKO outdoor conversion kit manual.



WARNING

**NO ELECTRICAL CONNECTION ALLOWED
for any outdoor installation!**

Kits & Accessories

Required Kits

Fuel Beds (choose one)		
700LSK	Traditional Log Set	
700DWK	Driftwood Log Set	
700BLK	Birch Log Set	
Liners (choose one)		
705LSLV3	Ledgestone Panels	
706RGL	Reflective Glass Panels	
707FBL	Fluted Black Panels	
708VRL	Valor Red Brick Panels	
Fronts (choose one)		Barrier Screen
709FT	Floating Trim Kits 3 Sided, various colors	4003381
713FF	Floating Trim Kits 4 Sided, various colors	
716EC	Edgemont Craftsman Fronts, various colors	4007965AZ
721ED	Edgemont Fronts, various colors	4003834
Backing Plates (choose one) (required for 716 and 721 fronts)		
717BPB	Floating 3-sided Backing Plate 36-1/4" W x 26-5/8" H	
717BPBF	Plaque de finition plate à 3 côtés 37-3/8" W x 27-1/4" H Require a deeper cavity	
719BPB	Floating 4-sided Backing Plate 36-1/4" W x 29-1/4" H	
Approved Venting Components		
See next page for list of approved venting components.		



Optional Accessories

Gas Conversion Kits	
700MNGK	Conversion Kit to Natural Gas
700MPGK	Conversion Kit to Propane Gas
Other Accessories	
710BPB	Backing Plate for 709 & 713 - 37-3/4" x 26-7/8"
714BPB	Backing Plate for 709 & 713 - 42" x 29"
725RT / 793RT	Riser trims for 3-sided fronts, various colors
795CFKV2*	Circulating Fan Kit
1265WSK	Wall Switch Kit
RBWSK	Remote Battery & Wall Switch Kit
GV60CKO*	Outdoor Fireplace Conversion Kit
Hearth Gate	Hearth gates such as Cardinal's VersaGate are available at retail stores carrying safety products for children.

 **WARNING**
*** NO ELECTRICAL CONNECTION ALLOWED for any outdoor installation!**

Information accurate at the time of printing and subject to change without notice.

Approved Venting Components

Approved Direct Vent Suppliers for Valor Models 700 ³ , 739 ² and 780 ³							
  Venting Parts Description		Venting Parts Code / availability by Manufacturer					
		DURA-VENT	SELKIRK	ICC EXCEL DIRECT	MILES INDUSTRIES	BDM	
Termination Caps	Vertical	Standard Co-axial	46DVA-VC	4DT-VT	—	—	DVR6-VCH DVR6-VCSB
		High Wind Co-axial	46DVA-VCH	—	TM-4SVT	—	—
		Extended Co-axial	46DVA-VCE	—	—	—	—
	Vertical	Co-linear	46DVA-CL33 46DVA-CL33H 46DVA-CL33P	—	TM-IVT	559CLT	940033B 940033HWS 940033RD
Horizontal	—		—	—	720SWK-M for 739M & 739V 720SWK-M2 for 700M, 700R, 780M & 780R	—	
Vent Adapters / Couplers	Universal Adapter 3" Flex Coupler		2150	—	TM-CFAA3	—	95090390
	Co-linear Flex Connector		46DVA-ADF	—	—	—	—
	Co-linear-to-Co-axial Adapter		46DVA-GK 46DVA-CLTA	—	TM-4CTA	—	—
Aluminum Flexible Liner	3" diameter		NOTE: 2-ply liner approved to CAN/ULC S635 suitable for venting gas appliances. As manufactured by Z-Flex, Flexmaster and others.				
			2280 Series	AF3-35L	TM-ALK33 TM-ALT33	—	952703
Flashings	Roof Flashing 0/12-6/12		46DVA-F6	4DT-AF6	TF-4FA	—	DVR6-AF012
	Roof Flashing 7/12-12/12		46DVA-F12	4DT-AF12	TF-4FB	—	DVR6-AF712
	Flat Roof Flashing		46DVA-FF	—	TF-4F	—	DVR6-TCF
	Masonry Flashing		—	—	TF-4MF	559FSK	

Notes:

1. Follow instructions supplied with each manufacturer's components.
2. The 720SWK-M Sidewall Kit can only be installed on the 739M and 739V models.
3. The 720SWK-M2 Sidewall Kit can only be installed on the 700M, 700R, 780M and 780R models.
4. Do not mix components from different vent manufacturers except those of Miles Industries which have been approved with other manufacturers'.

Dimensions & Cavity

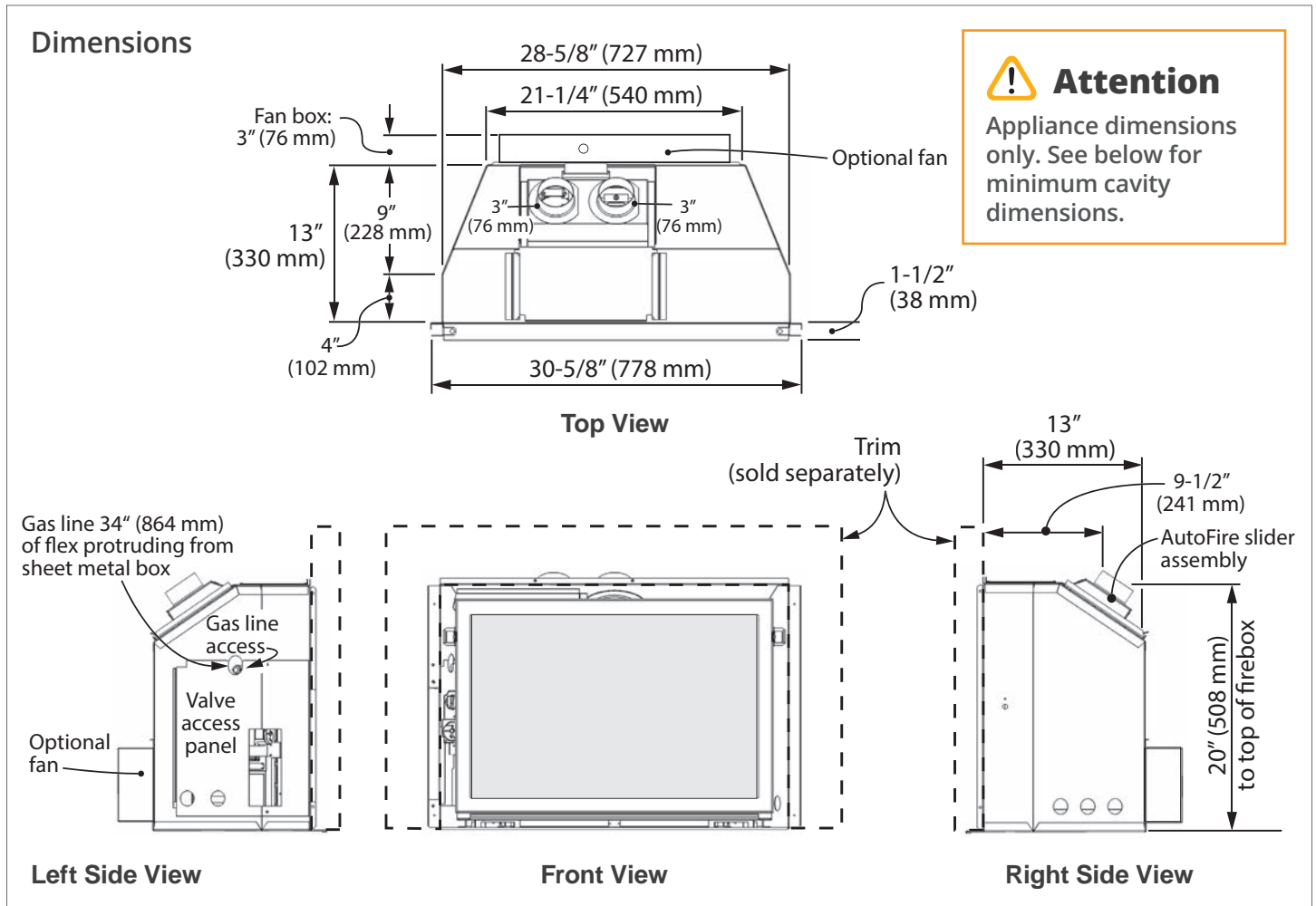

Cavity

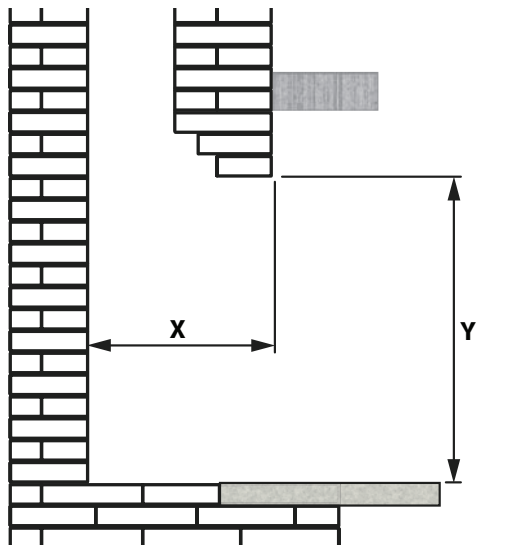

Minimum Cavity Dimensions

Check that masonry step does not interfere with install dimensions or vent pipe.

If mantel is combustible, see the following section for allowable clearances.

A hearth is not required, although any hearth/floor within 4" of the bottom of the unit must be non-combustible.

Minimum Dimension	With 717BPBF (Flat Plate)	With All Other (Floating) Backing Plates
Depth (X)	14-1/2" [368 mm]	13-1/2" [343 mm]
Depth with fan (X)	17-1/2" [445 mm]	16-1/2" [420 mm]
Height (Y)	22-3/8" [521 mm]	20-1/2" [521 mm]
Width (not shown)	30-7/8" [784 mm]	28-7/8" [734 mm]

Clearances

Mantel & Sidewall

Combustible Mantel—Left Side View

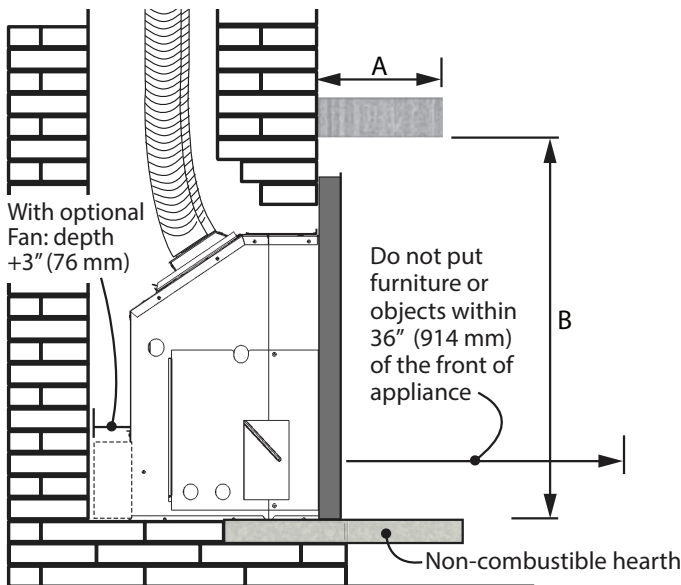

Combustible Mantel Clearances

Mantel Pro-jection A	0-6" (0-152 mm)	8" (203 mm)	10" (254 mm)	12" (305 mm)
Mantel Height B*	33" (838 mm)	35" (890 mm)	37" (940 mm)	39" (990 mm)

*Measure taken from the underside of the mantel to finished hearth or surface that the unit is sitting on.

Finishing Materials

Combustible materials: Materials made of or surfaced with wood, compressed paper, plant fibers, plastics, or other material that can ignite and burn, whether flame proofed or not, or plastered or unplastered.

Non-combustible materials: Material which will not ignite and burn. Such materials are those consisting entirely of steel, iron, brick, tile, concrete, slate, glass or plasters, or any combination thereof.

Materials that are reported as passing ASTM E 136, Standard Test Method for Behavior of Materials in a Vertical Tube Furnace at 750 °C

⚠ WARNING

HOT GLASS! The use of a screen in front of the glass is highly recommended particularly in households with children.

Sidewall Clearances

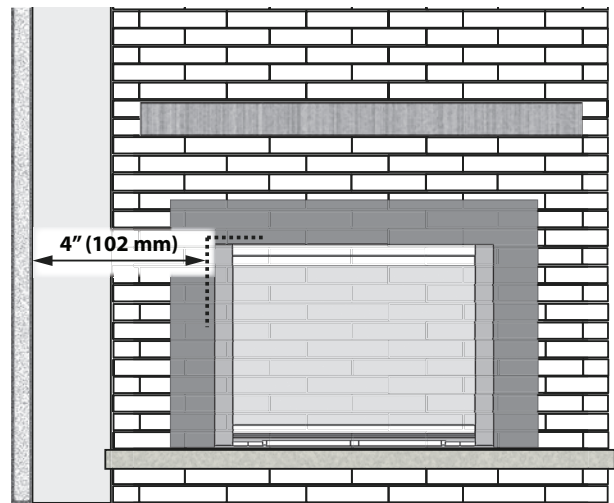

Minimum distance from side of appliance (liner box) to combustible wall: 4" (102 mm).

Floor/Hearth Clearances

Combustible shims/supports may be used beneath the appliance to level or raise the appliance within the existing fireplace cavity.

Combustible flooring/hearths **in front** of the appliance must be at a minimum of 4" (102 mm) below the bottom of the appliance. The gas insert does not require a hearth.

⚠ WARNING

Some materials or items, although safe, may discolor, shrink, warp, crack, peel, and so on because of the heat produced by the fireplace. Avoid placing candles, paintings, photos, and other items sensitive to heat around the fireplace.

⚠ WARNING

HOT HEARTH / FLOOR! The hearth or floor in front of the fireplace may become very hot when the fireplace heats. Do not use the hearth as a seat or shelf. Solid wood flooring in front of the fireplace (if allowed) may shrink during the heating season due to heat.

Clearances

720SWK-M2 Sidewall Vent Terminal

Horizontal Vent Termination Location

- The vent terminal must be located on an outside wall or through the roof.
- This direct vent appliance is designed to operate when an undisturbed airflow hits the outside vent terminal from any direction.
- The minimum clearances from this terminal that must be maintained when located on an outside wall are shown in figure below. Any reduction in these clearances could result in a disruption of the

airflow or a safety hazard. Local codes or regulations may require greater clearances.

- The vent terminal must not be recessed into a wall or siding.
- The vent terminal should be positioned where any snowdrifts will not cover it.
- Sidewall vent terminations require a terminal guard such as 658TG or 845TG when accessible—within 7' of ground.

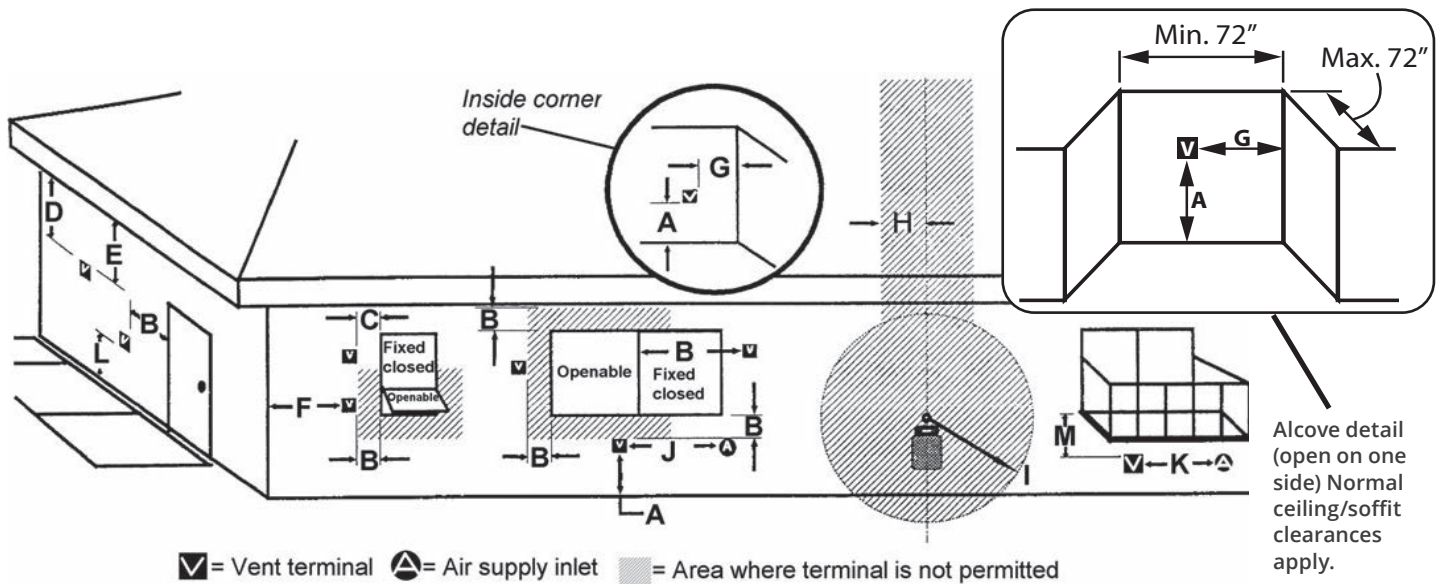

KEY	VENT TERMINAL LOCATIONS - MINIMUM DISTANCES	MINIMUM CLEARANCE	
		Inches	Cm
A	Clearance above grade, verandah, porch, deck or balcony	12	30
B	Clearance to window or door that may be opened	12	30
C	Clearance to permanently closed window (recommended to prevent condensation on window)	12	30
D	Vertical clearance to ventilated soffit located above the terminal within a horizontal distance of 2 feet (60 cm) from the center-line of the terminal	18	46
E	Clearance to unventilated soffit	12	30
F	Clearance to outside corner (measured from the center of vent)	12	30
G	Clearance to inside corner (measured from the center of vent)	12	30
H	Horizontal clearance to center-line of meter/regulator assembly located within 15 feet (4.6 m) below the terminal	36	90
I	Clearance to service regulator vent outlet	36	90
J	Clearance to non-mechanical air supply inlet to the building or the combustion air inlet to any other appliance	12	30
K	Clearance to a mechanical air supply inlet	72	180
L	Clearance above paved sidewalk or a paved driveway located on public property Note: A vent must not terminate directly above a sidewalk or paved driveway, which is located between two single-family dwellings and serves both dwellings. THIS DOES NOT APPLY to direct vent, non-condensing appliances in the Province of Ontario.	84	210
M	Clearance under a verandah, porch, deck or balcony Only permitted if veranda, porch, deck or balcony is fully open on a minimum of 2 sides beneath the floor	12	30

Note: Local codes and regulations may require different clearances.

Installation Planning

Before Installation



Caution

Only qualified, licensed, or trained personnel should install this appliance.

Installer - READ THIS FIRST!

1. YOU NEED TO KNOW FROM THE HOMEOWNER:
 - What accessories (surround, screen, fan*, etc) will be installed
2. Unpack the appliance, removing all items packed inside and around it. Recycle the packaging.
3. Check that you have everything, using the Pack Content sheet. Also, check that you have:
 - Fuel bed (packed separately)
 - Liner panels (packed separately)
 - Optional accessories (if ordered)
 - Gas conversion kit (if necessary)
 - Venting accessories
 - Electrical accessories* (if used)
4. Carefully read the Installer's Checklist included with the fireplace for the installation sequence.



WARNING

*** NO ELECTRICAL CONNECTION ALLOWED
for any outdoor installation!**

Installation Planning

Overview

This appliance may ONLY be installed in an existing unaltered, functioning solid-fuel burning fireplace with a working flue and constructed of non-combustible material.

This appliance may be installed in outdoor, weather protected environments as defined in the GV60CKO Outdoor Conversion Kit instruction manual.

DO NOT install into combustible construction. This appliance is NOT APPROVED for installation with a zero clearance kit.

WARNING

Some materials or items, although safe, may discolor, shrink, warp, crack, peel, and so on because of the heat produced by the fireplace. Avoid placing candles, paintings, photos, and other items sensitive to heat around the fireplace.

WARNING

HOT HEARTH / FLOOR! The hearth or floor in front of the fireplace may become very hot when the fireplace heats. Do not use the hearth as a seat or shelf. Solid wood flooring in front of the fireplace (if allowed) may shrink during the heating season due to heat.

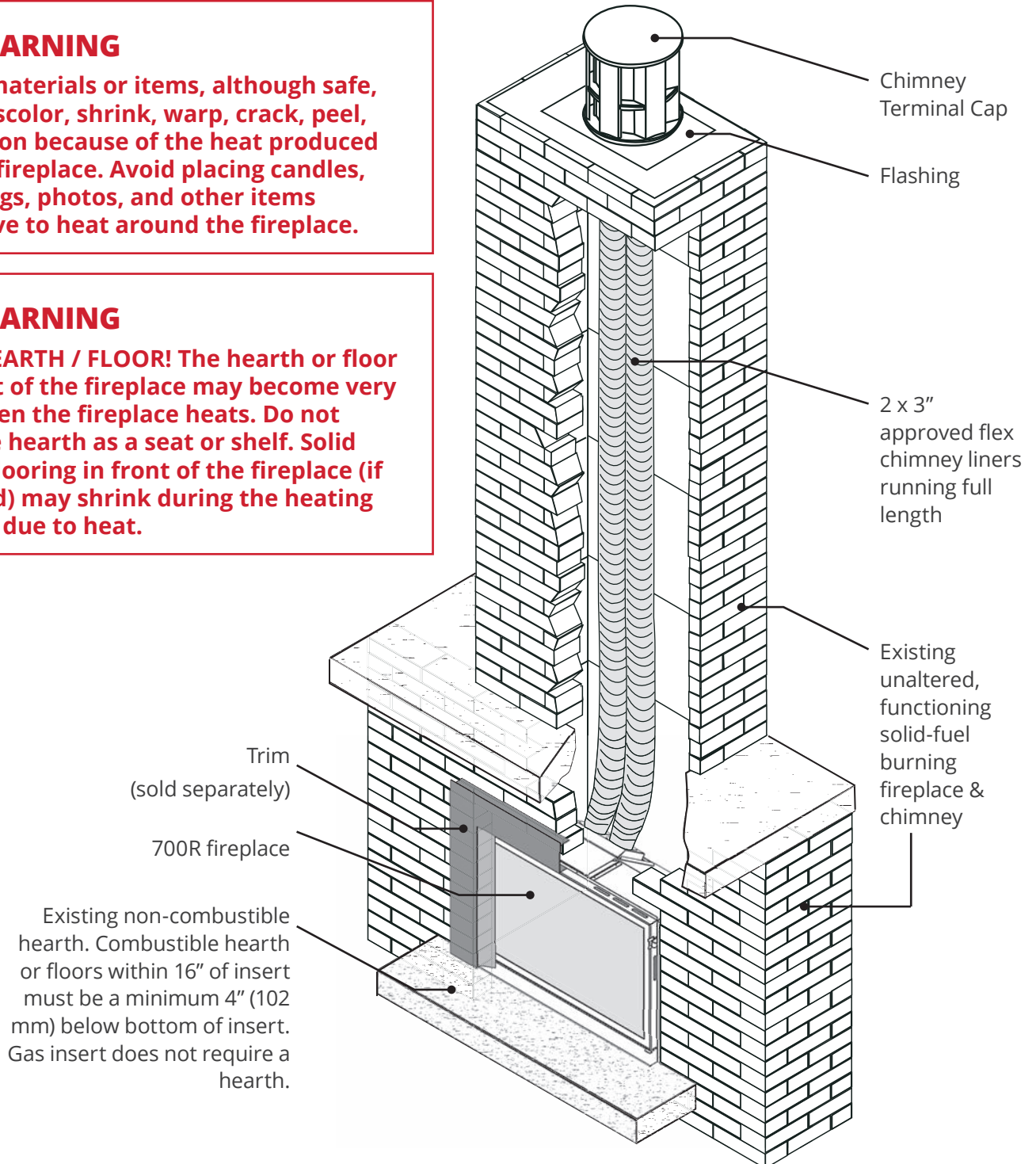

Venting

Overview

Typical Vent Installation

Flex liners may only be installed into solid-fuel burning fireplace and chimney systems (no combustible constructions).

The appliance must not be connected to a chimney flue serving a separate solid-fuel burner appliance.

See *Approved Venting Components* on page 8 of this manual. The appliance must not be connected to a chimney flue serving a separate solid-fuel burning appliance.

Vent Location

The vent terminal must be located through the roof. This direct vent appliance is designed to operate when an undisturbed airflow hits the outside vent terminal from any direction.

Check local codes for allowable vertical vent termination.

Venting Table

Maximum vertical height	40 ft (measured to bottom of termination)
Minimum vertical height	10 ft (measured to bottom of termination)
Maximum horizontal run	4 ft (measured center to center of pipe)
Maximum offset angle	45° (sweeping bend to allow for obstructions)

Venting Notes

Where possible, avoid joining flex pipes. If joints are required, use an approved connector and seal joints with RTV high temp sealant.

Horizontal offset is permissible to allow for routing around masonry projections. Avoid bending flex pipe over a 45 degree radius where possible.

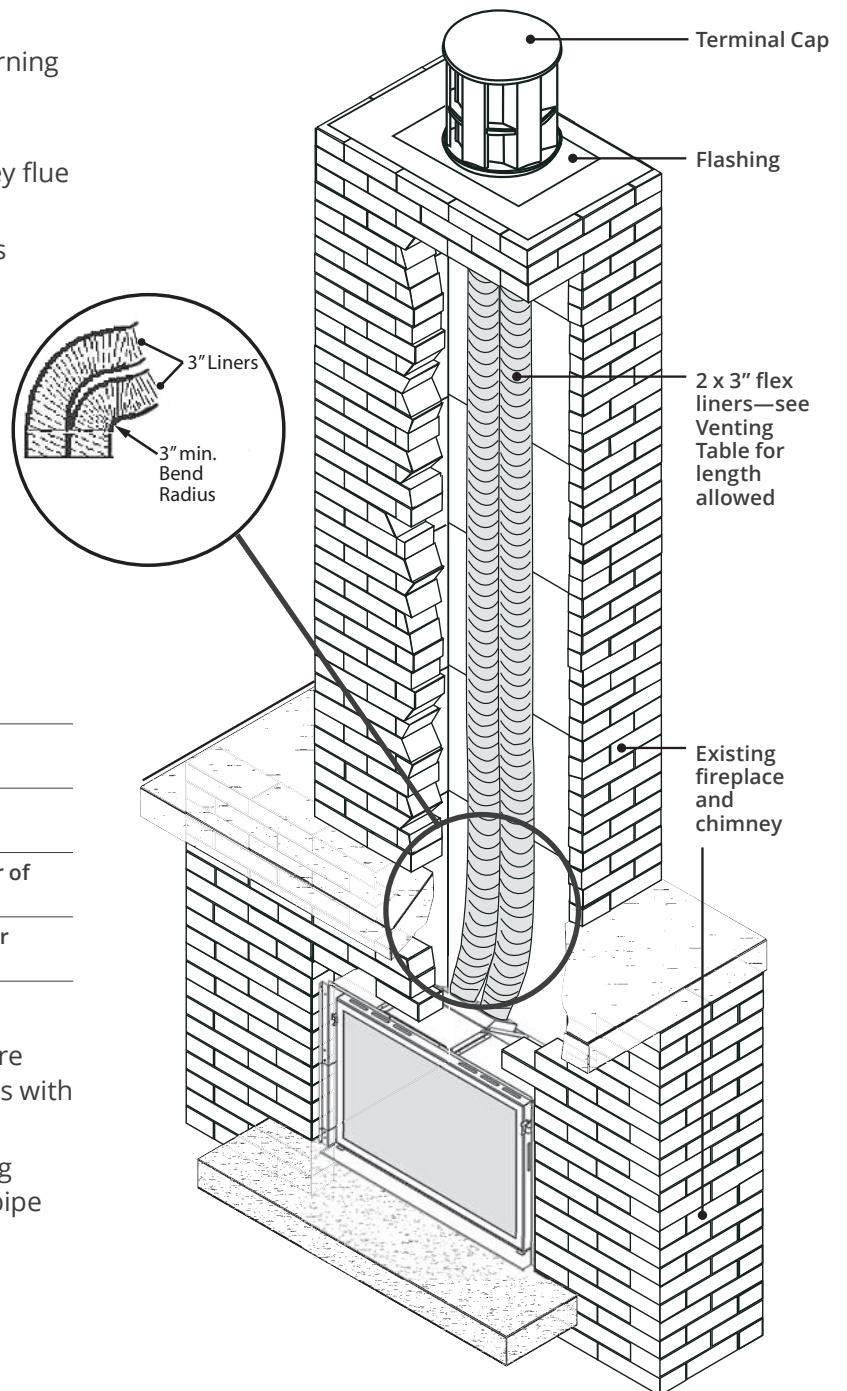

Alternate Venting with optional 720SWK-M2—Co-linear sidewall kit

The appliance may also be vented using the optional 720SWK-M2—Co-linear sidewall kit—see installation instructions supplied with the kit.

Terminal Clearances: see *720SWK-M2 Sidewall Vent Terminal* on page 11.

NOTE

Depending on the length of the vertical vent run, the AutoFire vent plate may need to be replaced by the vent plate included with the 720SWK-M2 terminal—see instructions provided with the terminal.

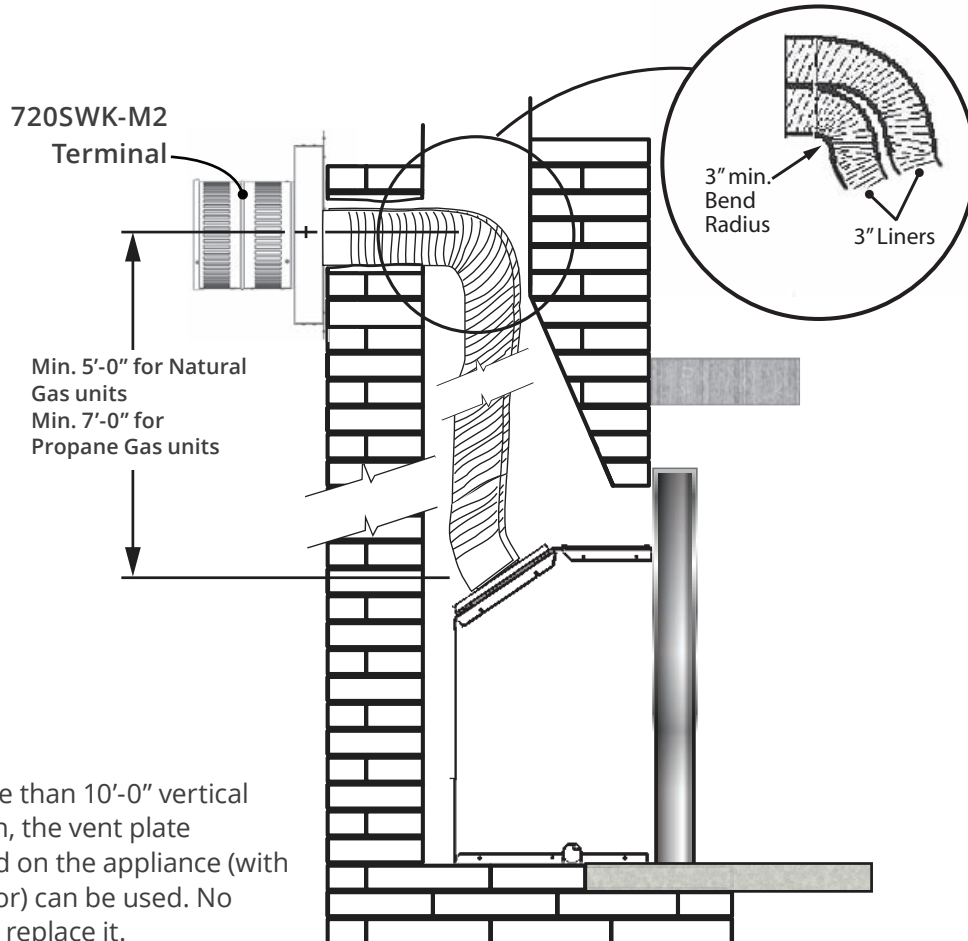

* If more than 10'-0" vertical vent run, the vent plate supplied on the appliance (with restrictor) can be used. No need to replace it.

Preparation

Existing Fireplace Preparation

A few points must be considered before inserting the 700 into an existing fireplace cavity. Generally, no modifications are allowed to the existing fireplace that will compromise the integrity of the existing fireplace.

Components that are bolted or screwed on such as dampers or baffles may be removed to accommodate the installation of the 700 engine. Refractory bricks and log grates may also be removed.

Cutting away any sheet metal parts of the existing fireplace to accommodate the installation of the 700 is prohibited.

Check with local authorities if in doubt.

Clean Fireplace and Chimney

Have the chimney swept and the fireplace cavity including ash dumps and clean-outs cleaned before installing the 700 heater and vent liners. Any creosote or soot residue remaining in the fireplace cavity chimney or clean-out may cause odors or stains once the 700 insert is installed. Consult with chimney sweep for information on how best to clean.

Existing Dampers

Factory-built, zero-clearance fireplaces will require the damper to be removed in order to install the vent liners. These dampers are usually bolted into place. Dampers in masonry fireplaces must be fixed open and may remain in place.

Ash Retaining Curbs

Some fireplaces (particularly factory-built) have a raised curb at the front edge to retain ashes. Check the dimensions carefully to ensure the 700 engine will fit behind any raised curb (some curbs may be removed separately from the refractory base).

Existing Fireplace Preparation

Gas Line Routing

Plan the routing of the gas line before proceeding. Utilize the existing hole for the gas line of the factory-built fireplace.

If the fireplace has no access hole, carefully drill an access hole of 1.5 inch (38 mm) or less through the lower sides or bottom of the firebox. The access hole must be plugged with non-combustible insulation after the gas supply line has been installed.

See Dimensions section for detailed location of gas inlet. Also, take into consideration whether or not a fan or shut-off valve will interfere when planning routing of the gas line.

Existing Glass Doors and Wire Screens

Existing glass doors must be permanently removed prior to installing the 700 insert.

Combustible Mantels

Combustible mantel clearances must conform to those required for the original solid-fuel fireplace into which the 700 is being installed.

Attach Warning Conversion Plate to Existing Fireplace

(plate supplied loose with 700 heater)

Attach the "This fireplace has been converted..." label to the existing fireplace using screws or other mechanical means and store any removed parts in back of the existing fireplace for future use.

Installation

Remove Window

The window is held in place by a spring-loaded lever on each side. To remove the window:

1. Locate the levers on each side of the window towards the top. Using your finger, pull the lever towards you and unhook it from the window frame bracket.

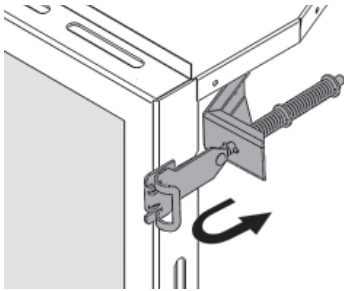

2. Carefully pull the top of the window outward.

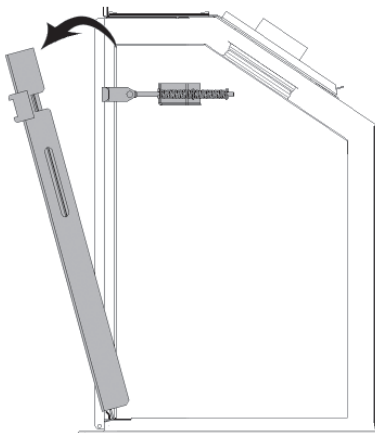

3. Lift the window out of its bottom railing and set it aside in a safe place to avoid damage.

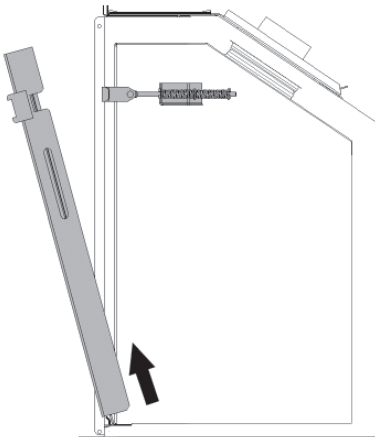

Window and Optional Fan

Install Fan Kit (if used)

If the 795CFKV2 Circulating Fan Kit (blower) is to be installed, we suggest that you do it now.

The fan cavity is accessible from the back of the firebox to facilitate its installation. If the fan is retrofitted after the installation of the appliance, the appliance will need to be removed. Therefore, we recommend that, where possible, the fan be installed before the appliance is fitted into the cavity.

Refer to instructions provided with the 795CFKV2 to install the fan.

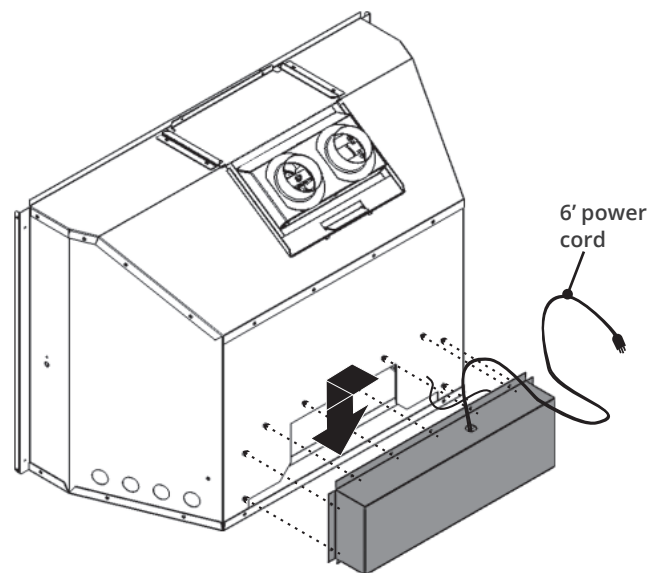

WARNING

**NO ELECTRICAL CONNECTION ALLOWED
for any outdoor installation!**

Installation

Venting

Connect Venting

IMPORTANT: This appliance's venting system is room sealed and therefore does not require room air to be used in the combustion process.

1. Rough-in two 3" diameter vent liners into the existing chimney system from the roof. Be careful not to tear or damage the liners in the process. It may be easier to install both liners at the same time rather than one at a time. Leave plenty of liners at the bottom to facilitate the connection of the liners to the vent slider. **It is best to leave the top termination until later. Designate and mark the top and bottom of one liner as "EXHAUST" to avoid confusion later.**
2. Release the two screws retaining the vent slider to the front of the firebox. Remove the slider from the firebox by sliding it towards the back of the firebox.
3. Fit the two liners ensuring that the *exhaust* liner is connected to the identified "EXHAUST" vent collar. Secure liners to collars with hose clamps (included) and 2 tapping screws per liner.
4. Slide the firebox onto the vent slider in the cavity taking care not to damage the liners. **Make sure that the rear edge of the slider is hooked over the cleat on the firebox.** Secure the vent slider to the front of the firebox with two screws removed earlier.
5. From the roof, pull the liners and fit the flashing.
6. Fit the terminal cap ensuring that the *exhaust* liner is connected to the *exhaust* vent collar. Secure with screws.
7. Seal the terminal and flashing from water penetration as required.

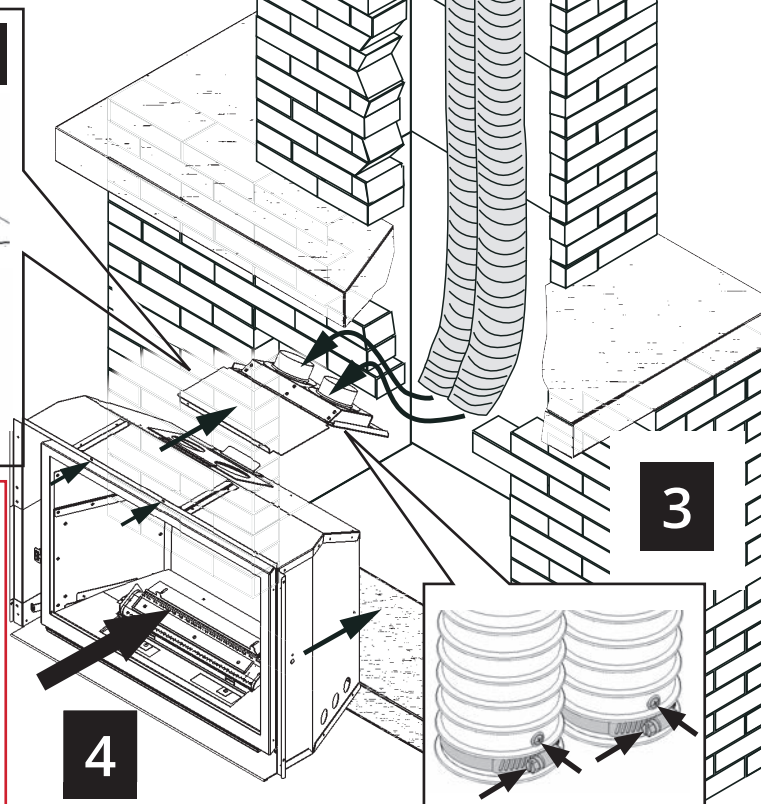
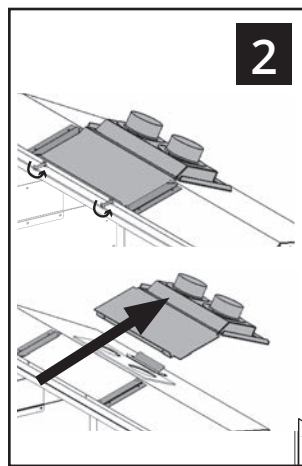
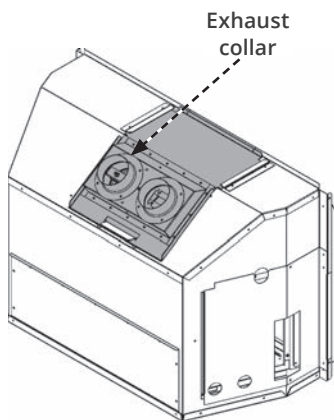

⚠ WARNING
Failure to position the parts in accordance with these diagrams or failure to use only parts specifically approved with this appliance may result in property damage or personal injury.

Installation

Gas Supply

Connect Gas Supply

The gas supply inlet connection is a 1/2" NPT female. Gas shut-off valve supplied on the end of stainless steel flexible connector. Flex connector is located on the left hand rear corner of the appliance.

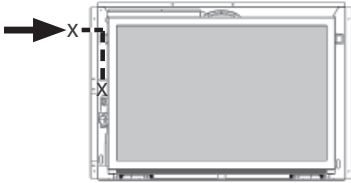

Use only new black iron or steel pipes, CSST, or copper tubing if acceptable—check local codes. Note that in USA, copper tubing must be internally tinned for protection against sulfur compounds.

The burner module and gas train on this appliance may be removed as a unit for servicing. The flex pipe supplied with the unit provides a union for removal of the module.

Unions in gas lines should be of ground joint type.

The gas supply line must be sized and installed to provide a supply of gas sufficient to meet the maximum demand of the appliance without undue loss of pressure.

Sealant used must be resistant to the action of all gas constituents including LP gas. Sealant should be applied lightly to male threads to ensure excess sealant does not enter gas lines.

Pressure test the supply line for leaks.

The appliance and its individual shut-off valve must be disconnected from the gas supply piping system during any pressure testing of that system at test pressures in excess of 1/2 psig (3.5 kPa).

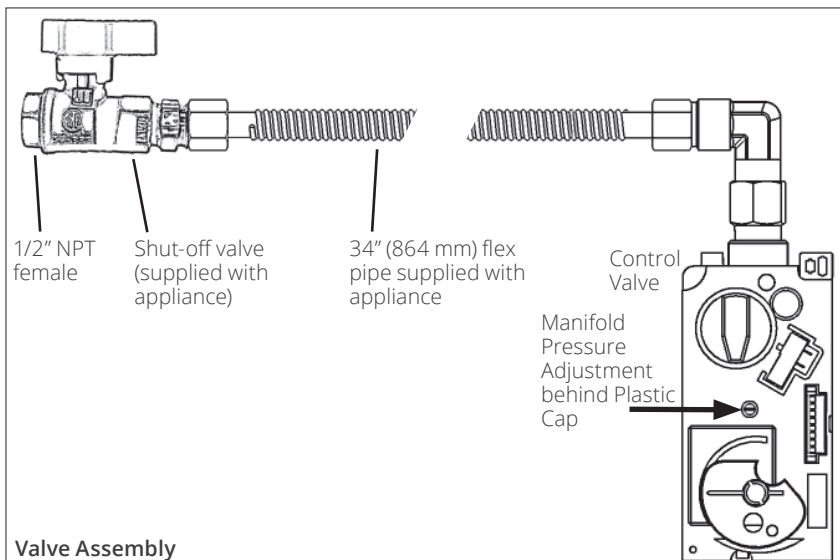

The appliance must be isolated from the gas supply piping system by closing its equipment shut-off valve during any pressure testing of the gas supply piping system at test pressures equal to or less than 1/2 psi (3.5 kPa).

Failure to either disconnect or isolate the appliance during pressure testing may result in regulator or valve damage and void the warranty. Consult your dealer in case of damage.

Pressure Test Points

The minimum supply pressure is given in the section Specifications of this manual—page 6.

All piping and connections must be tested for leaks after installation or servicing. All leaks must be corrected immediately.

When testing for leaks:

- Make sure that the appliance is turned off.
- Open the manual shut-off valve.
- Test for leaks by applying a liquid detergent or soap solution to all joints. Bubbles forming indicate a gas leak.

Never use an open flame to check for leaks.
Correct any leak detected immediately.

The pressure test tapping locations are shown in the figure below. An internal regulator within the valve controls the burner manifold pressure.

The correct pressure range is shown in the table in section Specifications of this manual on page 6. The pressure check should be made with the burner alight and at its highest setting. See Lighting Instructions section for full operating details on page 39.

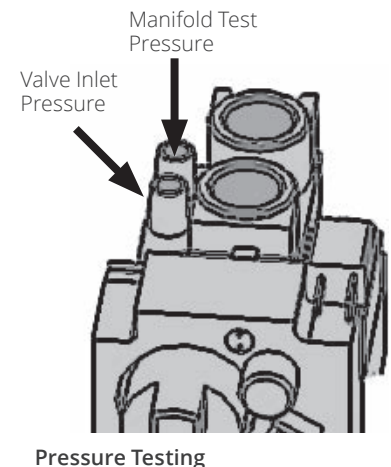

Installation

Gas Supply

Inlet Connection

The appliance is supplied with a flared elbow connector fitted onto the valve and a flex connector supplied loose to be attached to the elbow connector. To facilitate the installation of the flex connector, remove the valve access panel on the left side of the appliance case.

NOTE: The flex connector minimum bend radius must be no smaller than the size of a golf ball (approx. 1-3/4" or 44 mm) as indicated.

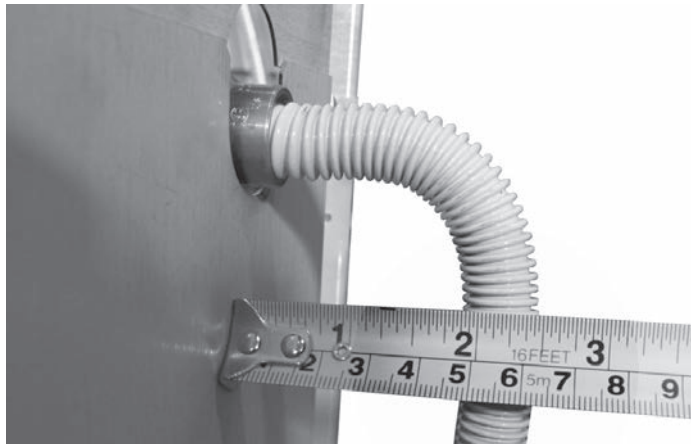
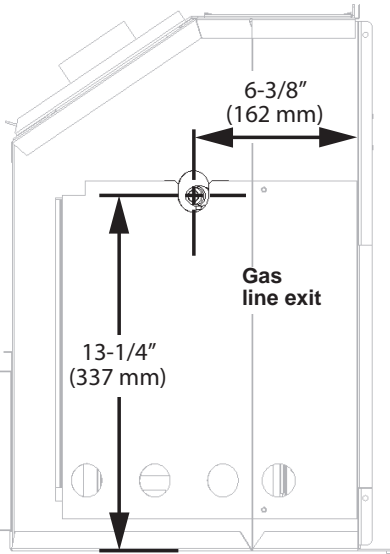

Alternate Inlet Connection

When the fireplace opening width is too narrow, you may use common elbows and fittings (not supplied) to redirect the position of the flex connector closer to the side of the appliance.

1. Remove elbow connector.

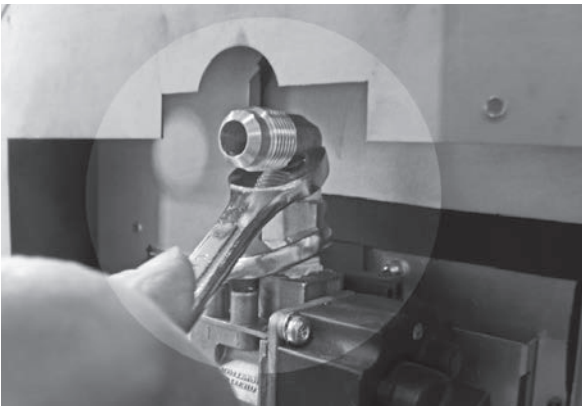

2. Install alternate elbow (not supplied).

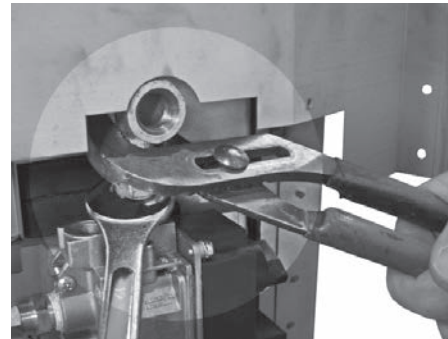

3. Re-install original supplied connector elbow.

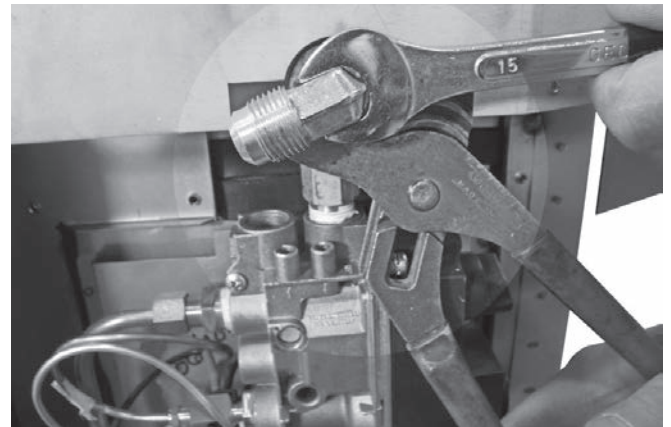

4. Install the flex connector to the alternate elbow.

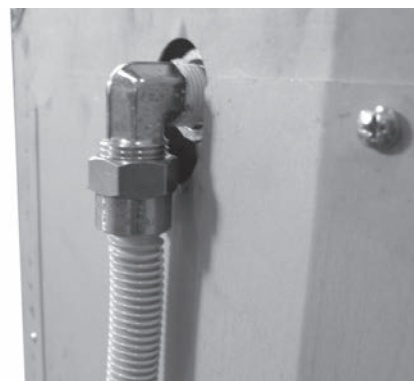

Installation

Liners

Liner Installation

The following guidelines apply to all panels except 706RGL Reflective Glass Liners, for which separate instructions are provided with that kit.

Note that if the liner kits came with two front base panels, these may be disposed of as they are not used in this appliance.

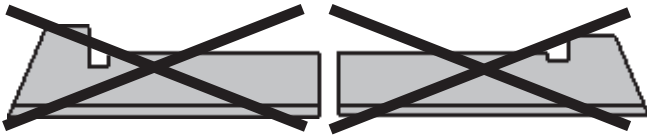

1. Remove the log support (2 screws).

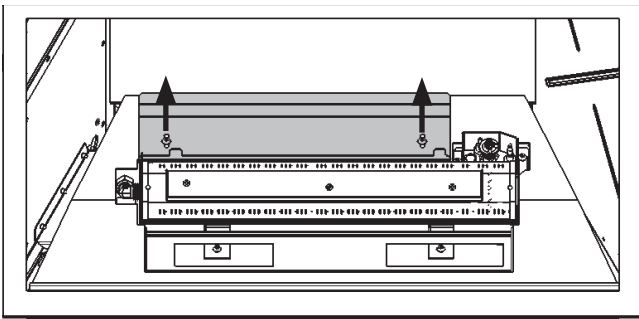

2. Remove the burner cover (2 screws).

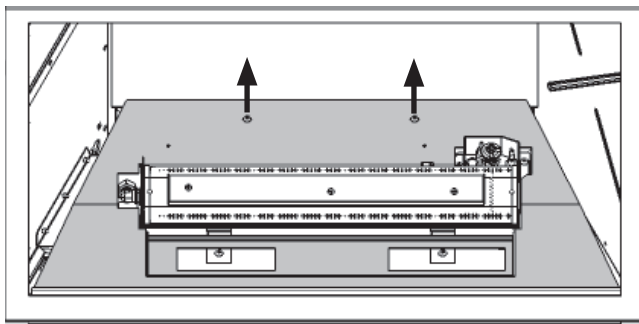

3. Inside the firebox, on the top of each side, release the screw of the side brick anchors (one per side) just enough to allow them to rotate.

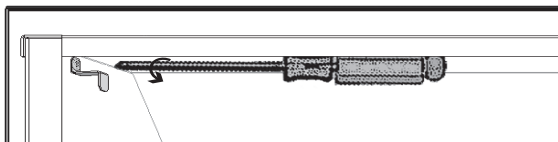

4. Install the rear panel on the rail behind the burner, against the back of the firebox. The angled edge faces the top of the firebox. Support the rear panel with your hand.

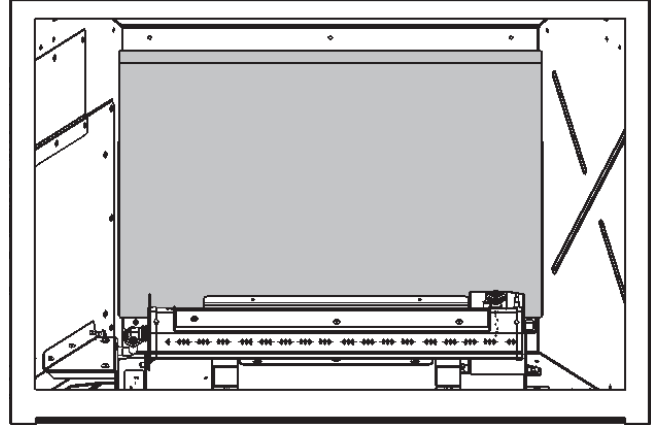

5. Install the left hand panel against the inside of the firebox, bottom edge first. Rotate the anchor down to hold the panel.

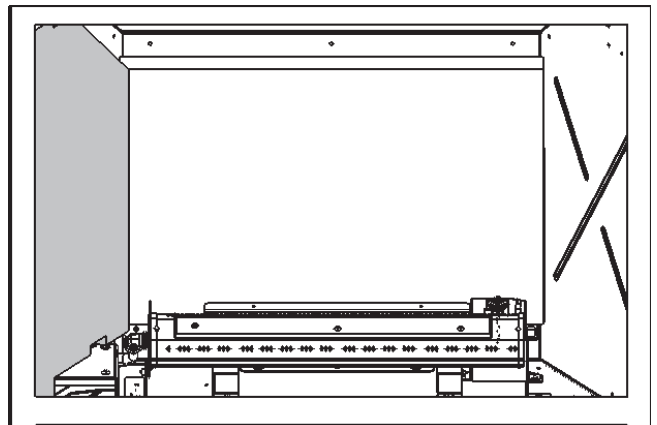

6. Install the right hand panel against the inside of the firebox, bottom edge first. Rotate the anchor down to hold the panel.

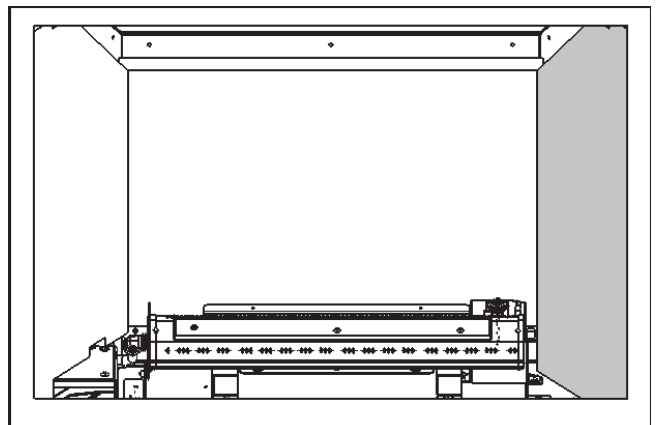

Installation

Liners

7. Install the roof panel, supporting it with the rear and side panels.

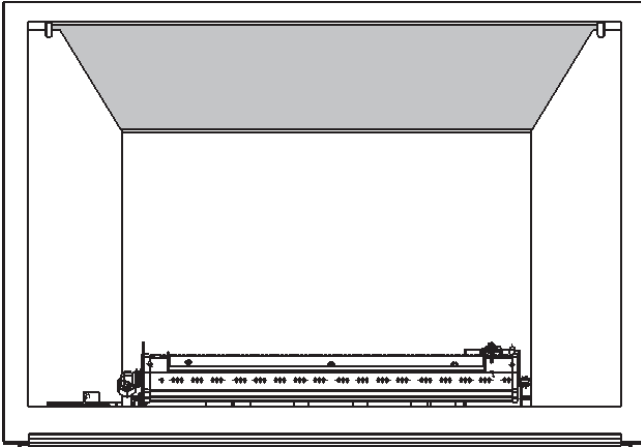

8. Tighten the anchor screws on each side.

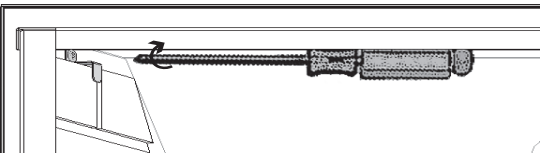

9. Replace the burner cover (2 screws).

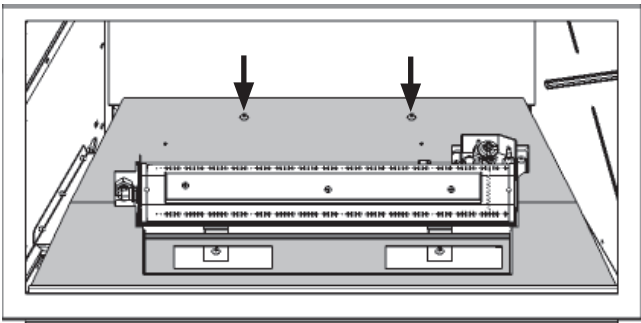

10. Replace the log support (2 screws).

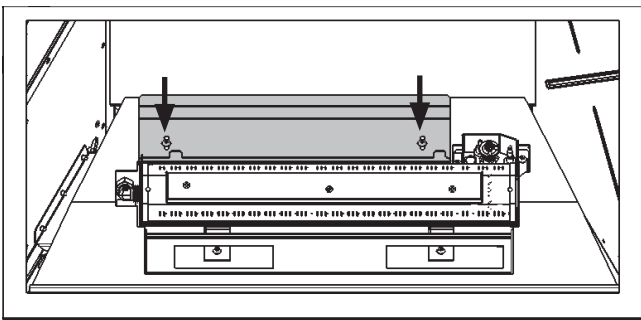

Installation

Fuel Beds

Birch Log Kit 700BLK

Material required

- Birch Log Kit, which contains:
 - 10 logs
 - 1 bag of embers
- Gloves, if desired (not included)

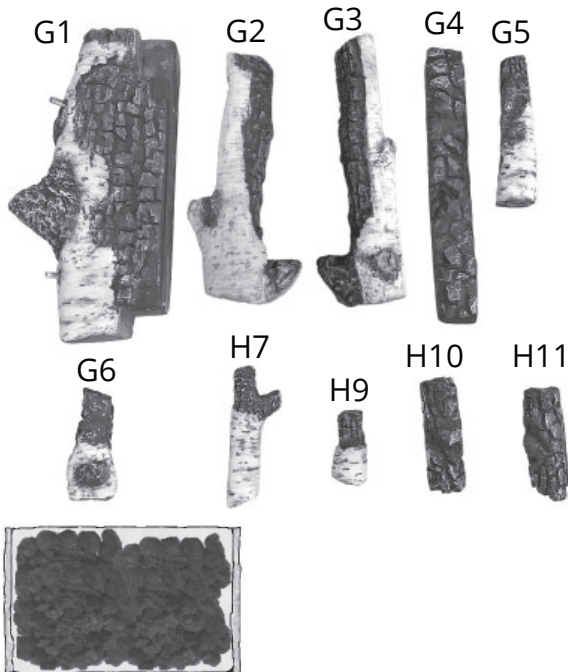

Installation

Carefully unpack the kit. Note each log has its own number stamped on the bottom. Some logs have pegs to help you place them on the burner platform, or other logs.

Install the logs as shown below.

1. Confirm the front edge of the rear log support is flush with the cutout in the burner support platform.

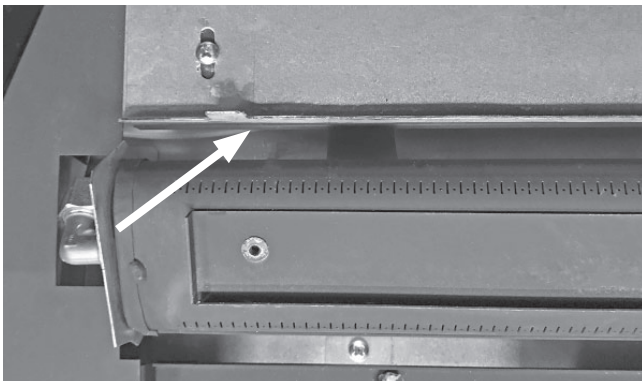

2. Place log G4 directly on the burner, and slide it all the way to the left. There is a groove on the underside of the log that fits on the front rail on the burner.

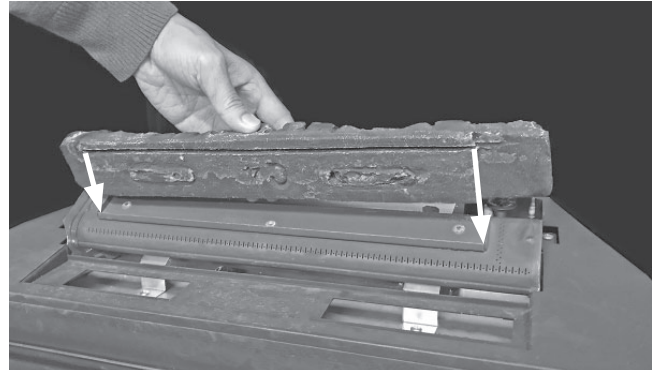

3. Place log H10 in the front left cutout in the burner platform with the long end pointing to the left.



4. Place log H11 in the front right cutout in the burner platform. Orient the H11 with its angled end pointing to the right.



Installation

Fuel Beds

5. Place embers in the gap between H10 and H11, and behind H10 and H11, against the burner. Hold some embers back for later steps.

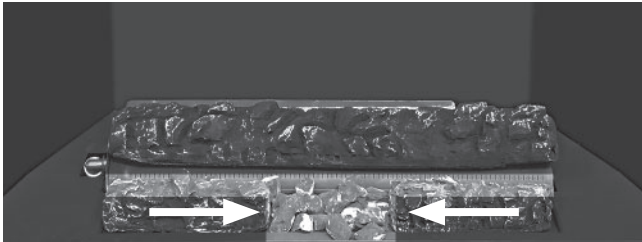

6. Place log G1 on the rear log support as shown, behind the tabs. Slide it to the right until it presses gently against the pilot shield.

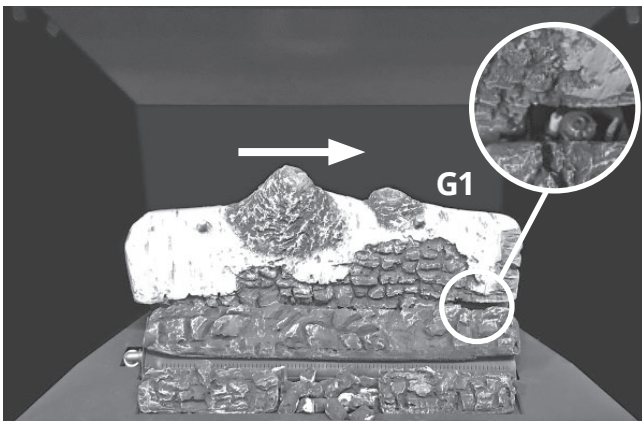

7. Place log G6 as shown, on top of H11 and G4.

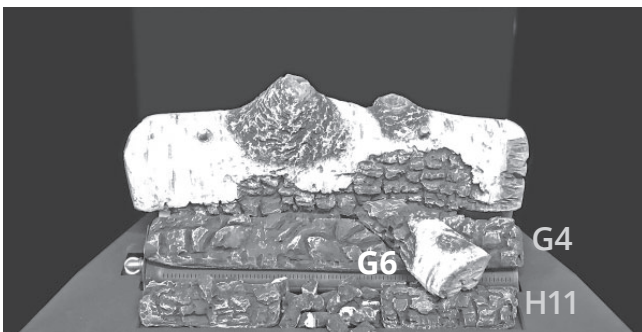

8. Place log G5 as shown, on top of H10 and G6. The bottom of the log rests against a raised knob on H10.

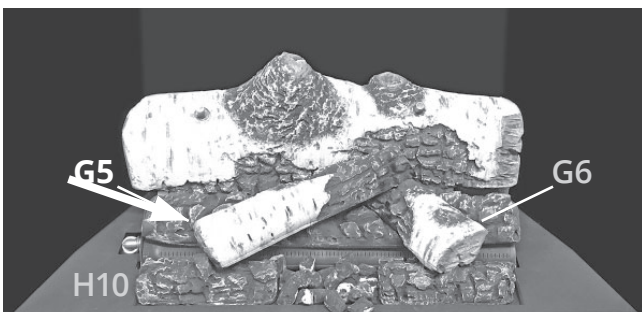

9. Place log H7 as shown, on top of G5 and G4.

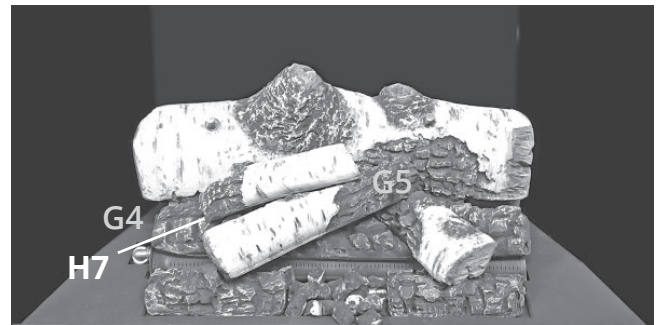

10. Place the hole in log G3 onto the right pin on G1, and rest the other end on the platform.

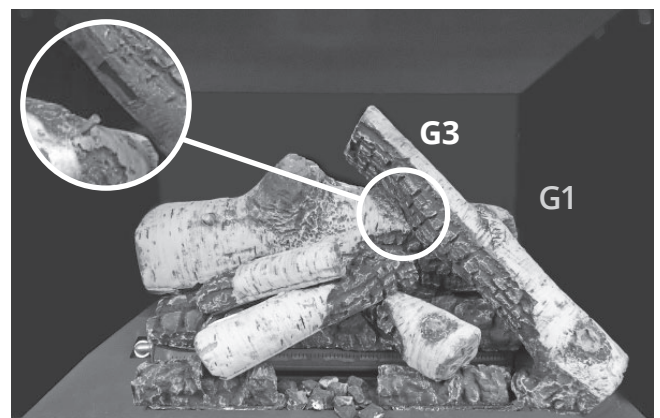

11. Place the hole in log G2 onto the left pin on G1, and rest the other end on the platform.

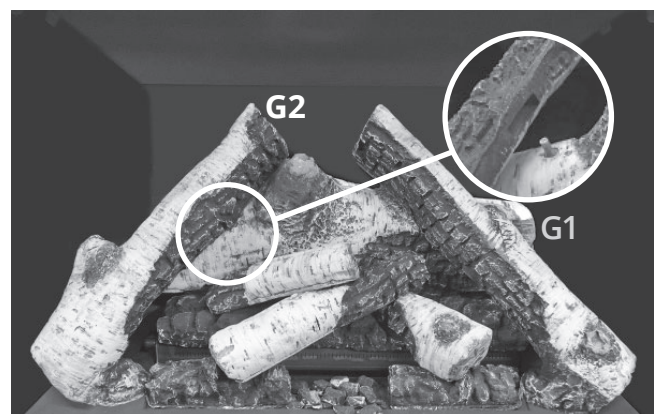

Installation

Fuel Beds

12. Place log H9 on top of the embers at the front of the fireplace, between H10 and H11.

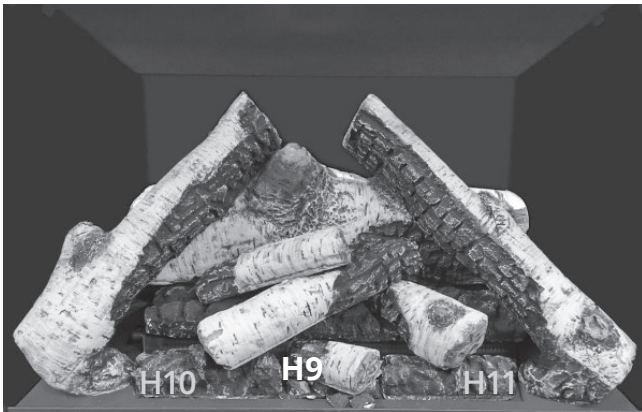

IMPORTANT

Approved for use only with the ceramic embers provided with your Valor fireplace. The use of any other products may void your fireplace warranty.

WARNING

Choking Hazard! Ensure that the fireplace area is clear of embers as these could be ingested by small children. Vacuum area after installation.

13. Place remaining embers as desired along front and sides. You may not need to place all embers.

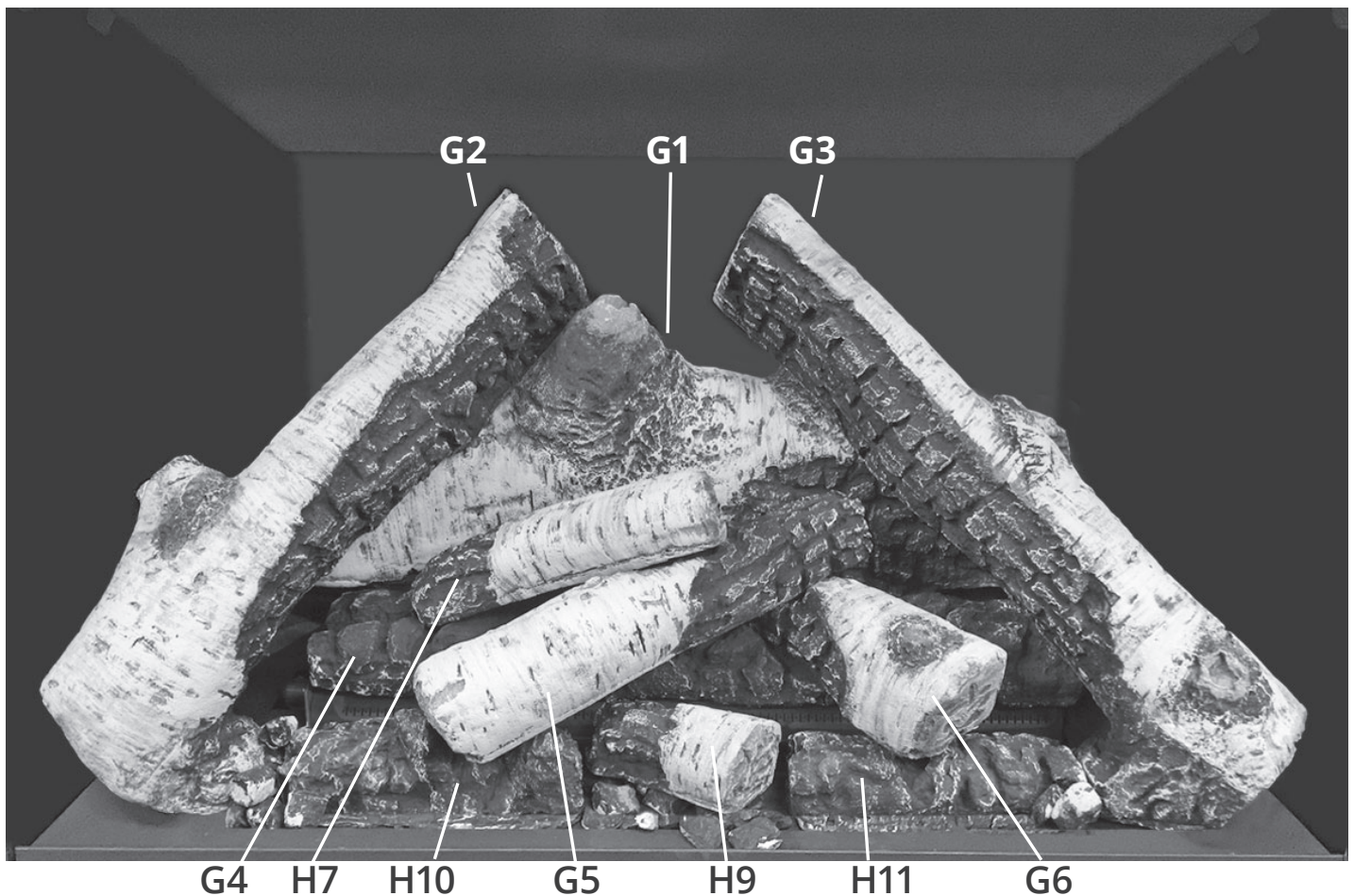

Installation

Fuel Beds

Traditional Log Kit 700LSK

Material required

- Traditional Log Kit, which contains:
 - 10 logs
 - 1 bag of embers
- Gloves, if desired (not included)

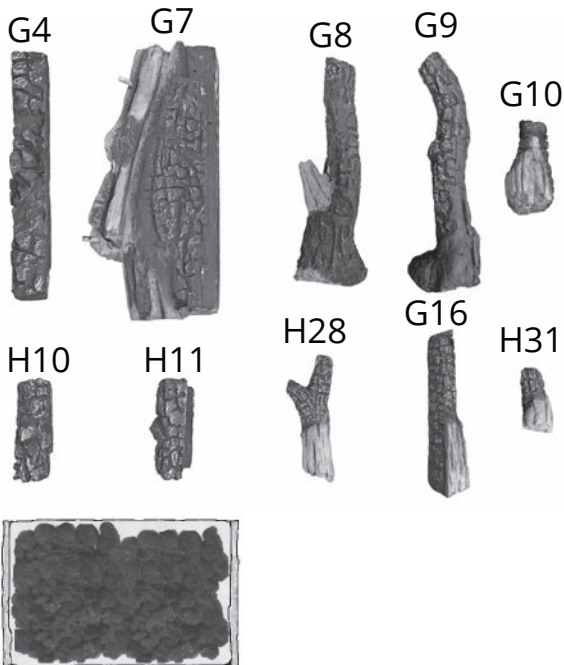

Installation

Carefully unpack the kit. Note each log has its own number stamped on the bottom. Some logs have pegs to help you place them on the burner platform, or other logs.

Install the logs as shown below.

1. Confirm the front edge of the rear log support is flush with the cutout in the burner support platform.

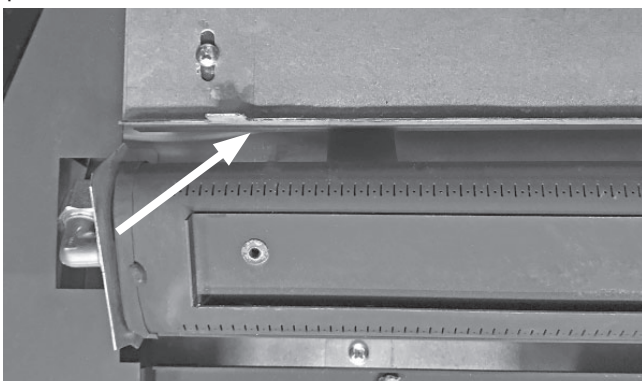

2. Place log G4 directly on the burner, and slide it all the way to the left. There is a groove on the underside of the log that fits on the front rail on the burner.

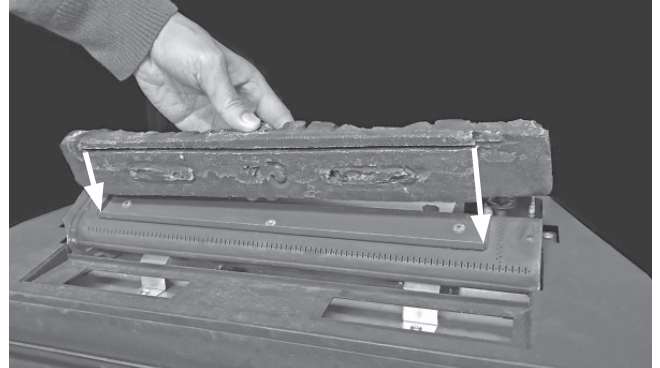

3. Place log H10 in the front left cutout in the burner platform with its long end pointed to the left.



4. Place log H11 in the front right cutout in the burner platform. Orient the H11 with its angled end pointing to the right.

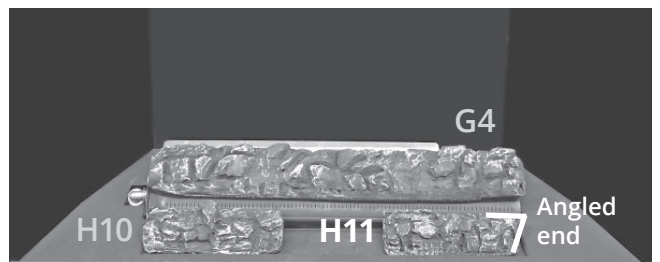

Installation

Fuel Beds

5. Place embers in the gap between H10 and H11, and behind H10 and H11, against the burner. Hold some embers back for later steps.

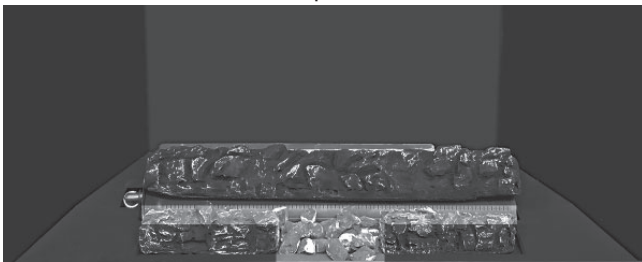

6. Place log G7 on the rear log support as shown, behind the tabs. Slide it to the right until it presses gently against the pilot shield.

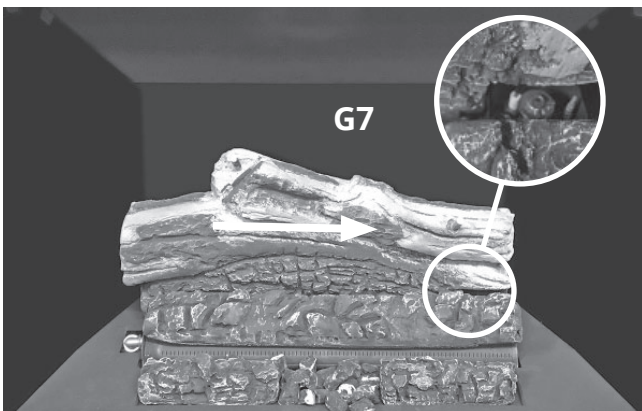

7. Place log G10 on top of G4 and H11.

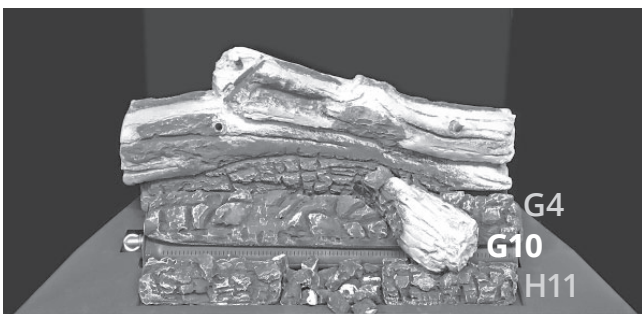

8. Place log G16 on top of H10, and into the groove on top of G10.

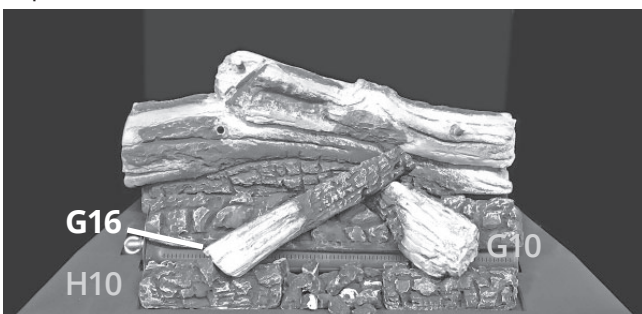

9. Place log H28 on top of G16 and G4.

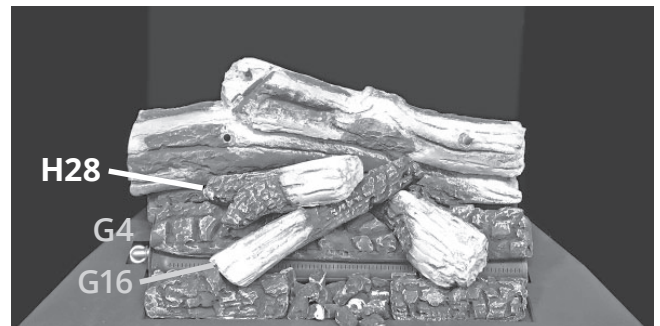

10. Place log G9 onto the right hand pin on G7 and onto the platform as shown.

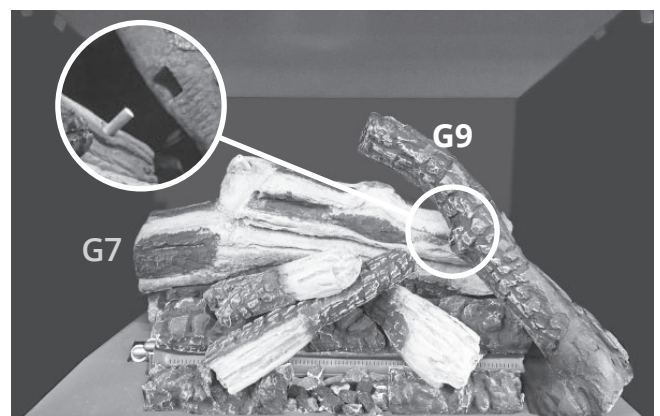

11. Place log G8 onto the left hand pin on G7 and onto the platform as shown.

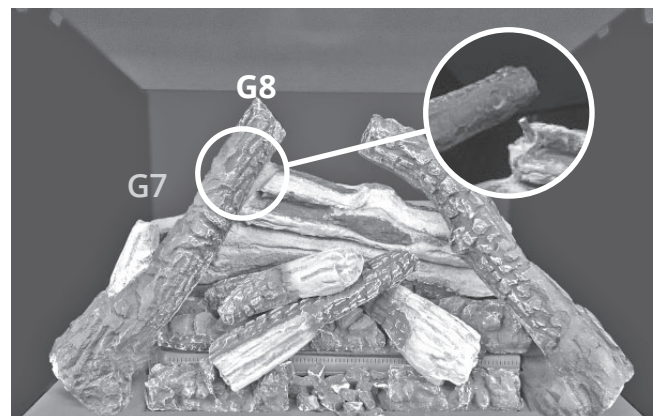

Installation

Fuel Beds

12. Place log H31 on top of the embers between H10 and H11.

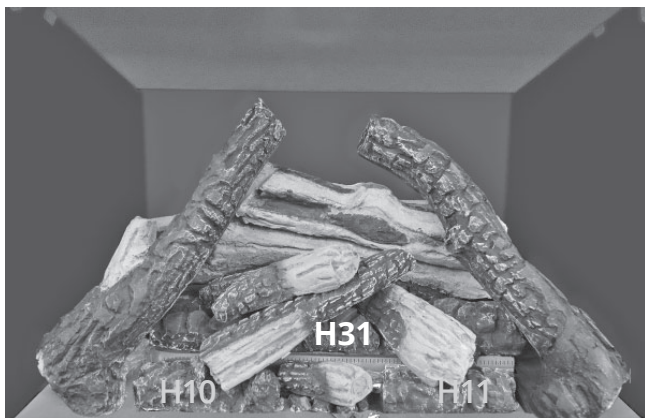

IMPORTANT

Approved for use only with the ceramic embers provided with your Valor fireplace. The use of any other products may void your fireplace warranty.

WARNING

Choking Hazard! Ensure that the fireplace area is clear of embers as these could be ingested by small children. Vacuum area after installation.

13. Place remaining embers as desired along front and sides. You may not need to use all embers.

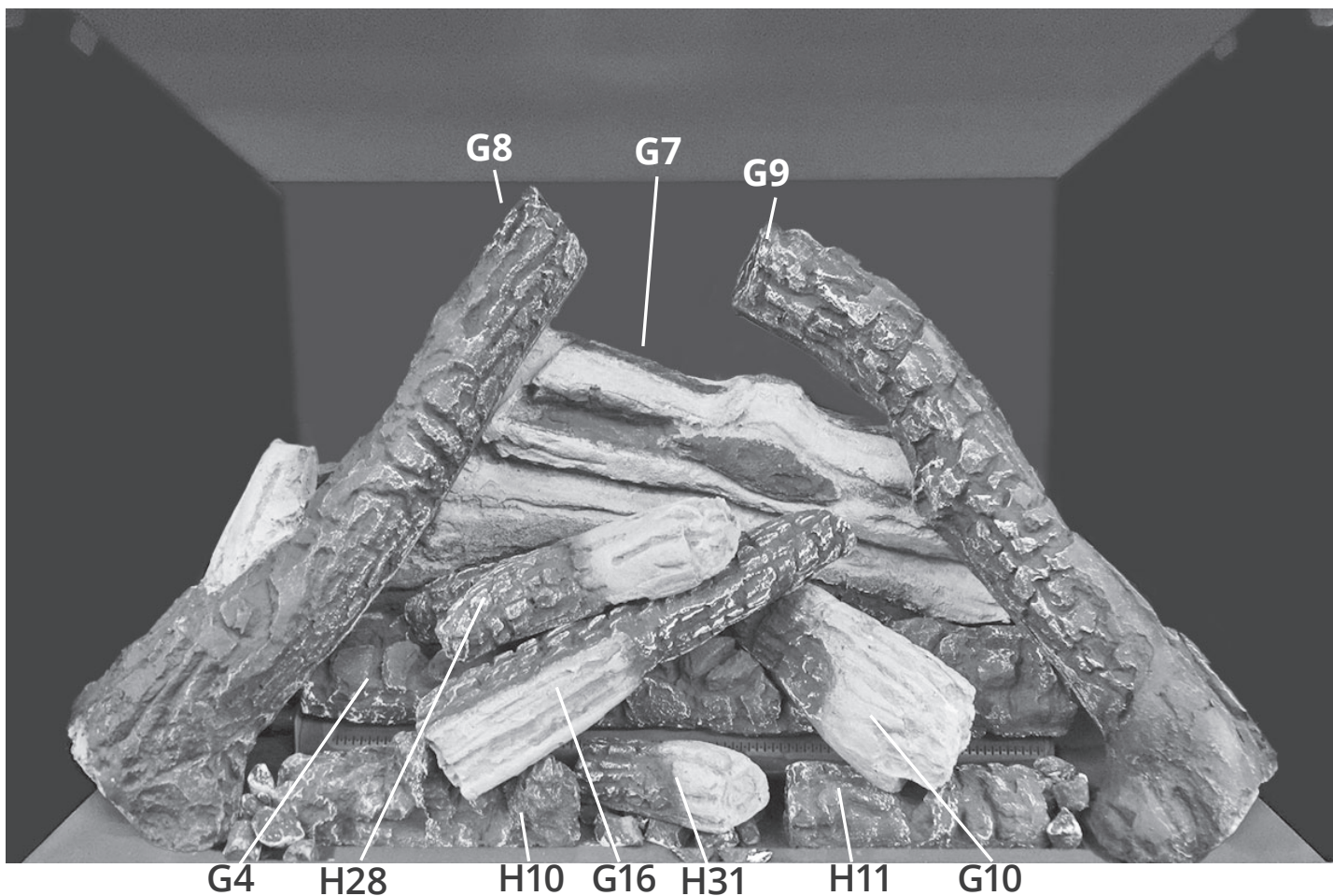

Installation

Fuel Beds

Driftwood Log Kit 700DWK

Material required

- Traditional Log Kit, which contains:
 - 8 logs
 - 3 pebbles
 - 1 bag of embers
 - 1 steel cover panel, supplied with the logs or fireplace
- Gloves, if desired

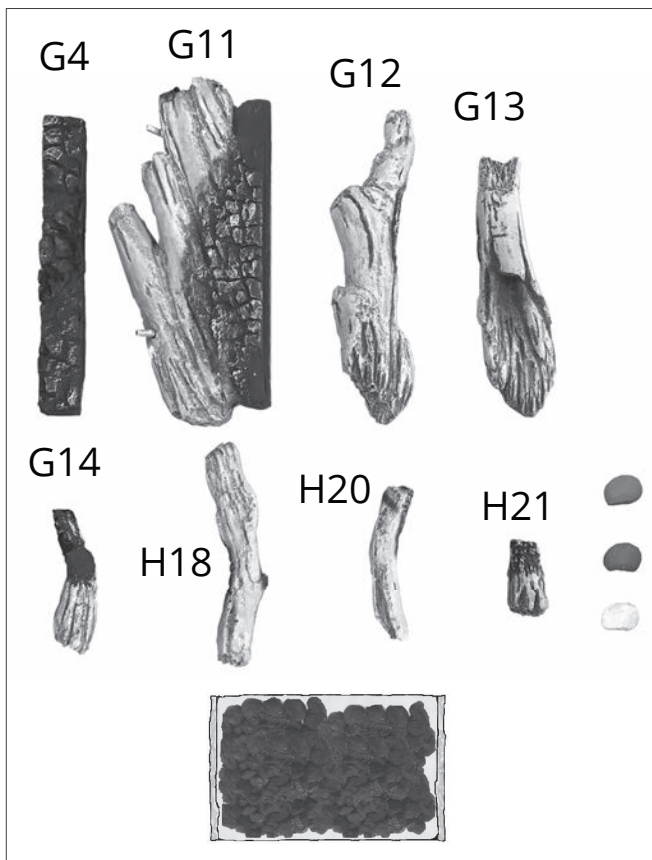

Installation

Carefully unpack the kit. Note each log has its own number stamped on the bottom. Some logs have pegs to help you place them on the burner platform, or other logs.

Install the logs as shown below.

1. Confirm the front edge of the rear log support is flush with the cutout in the burner support platform.

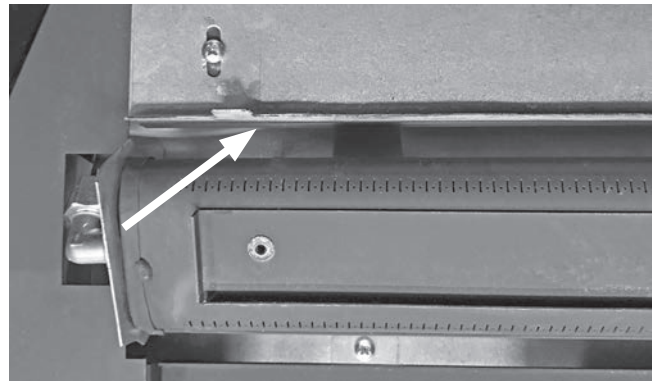

2. Place log G4 directly on the burner, and slide it all the way to the left. There is a groove on the underside of the log that fits on the front rail on the burner.

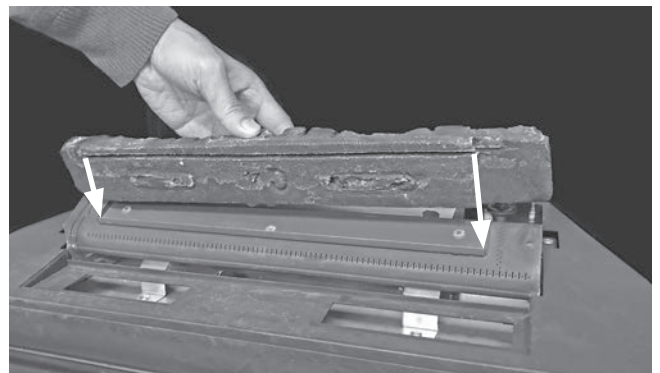

Installation

Fuel Beds

- Place log G11 on the rear log support as shown, behind the tabs. Slide it to the right until it presses gently against the pilot shield.

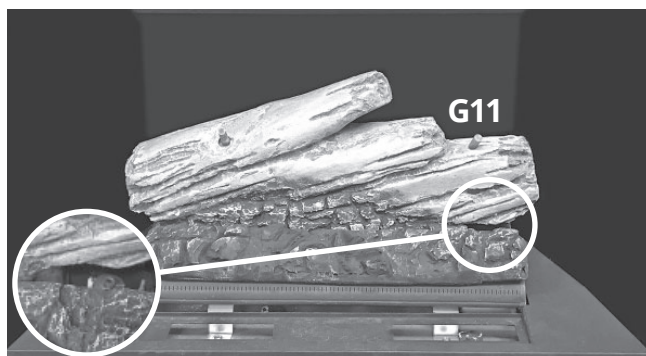

- Place the cover plate that came with the logs or fireplace into the depression in the platform in front of G4.



- Place log G14 on top of G4 and into the platform depression. It should rest against the inside of the front edge of the depression.

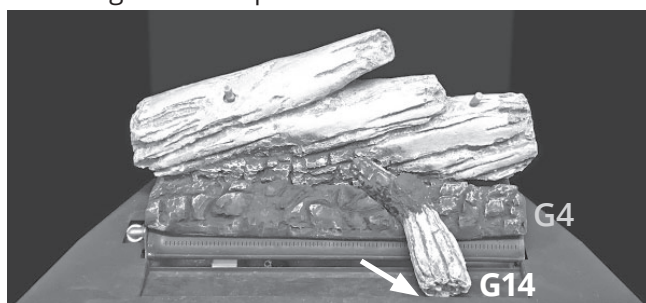

- Place log H18 on top of G14 and into the platform depression. It should rest against the inside of the front edge of the depression.

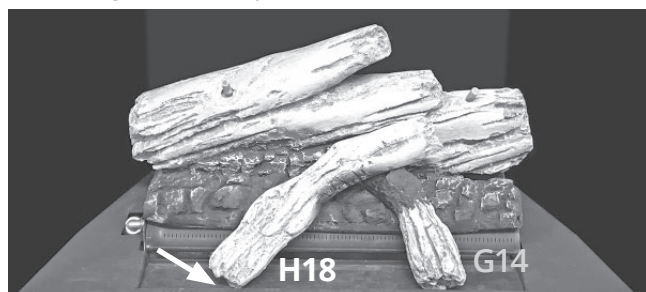

- Place H20 on top of H18 and G4 as shown. H20 rests on top of a knob on G4.



- Place embers in the depression in front of G4, around the base of log H18 and G14.



- Place log G13 onto the right hand pin on G11 and onto the platform as shown.

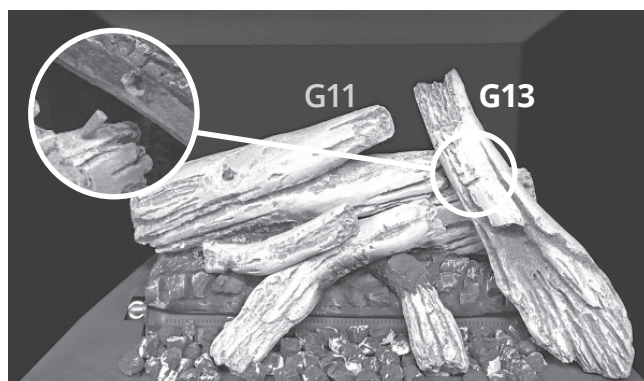

Installation

Fuel Beds

10. Place log G12 onto the left hand pin on G11 and onto the platform as shown.



12. Place pebbles to taste around the front of the assembly.



11. Place log H21 on top of the embers between H18 and G14.



IMPORTANT

Approved for use only with the ceramic embers provided with your Valor fireplace. The use of any other products may void your fireplace warranty.

WARNING

Choking Hazard! Ensure that the fireplace area is clear of embers as these could be ingested by small children. Vacuum area after installation.

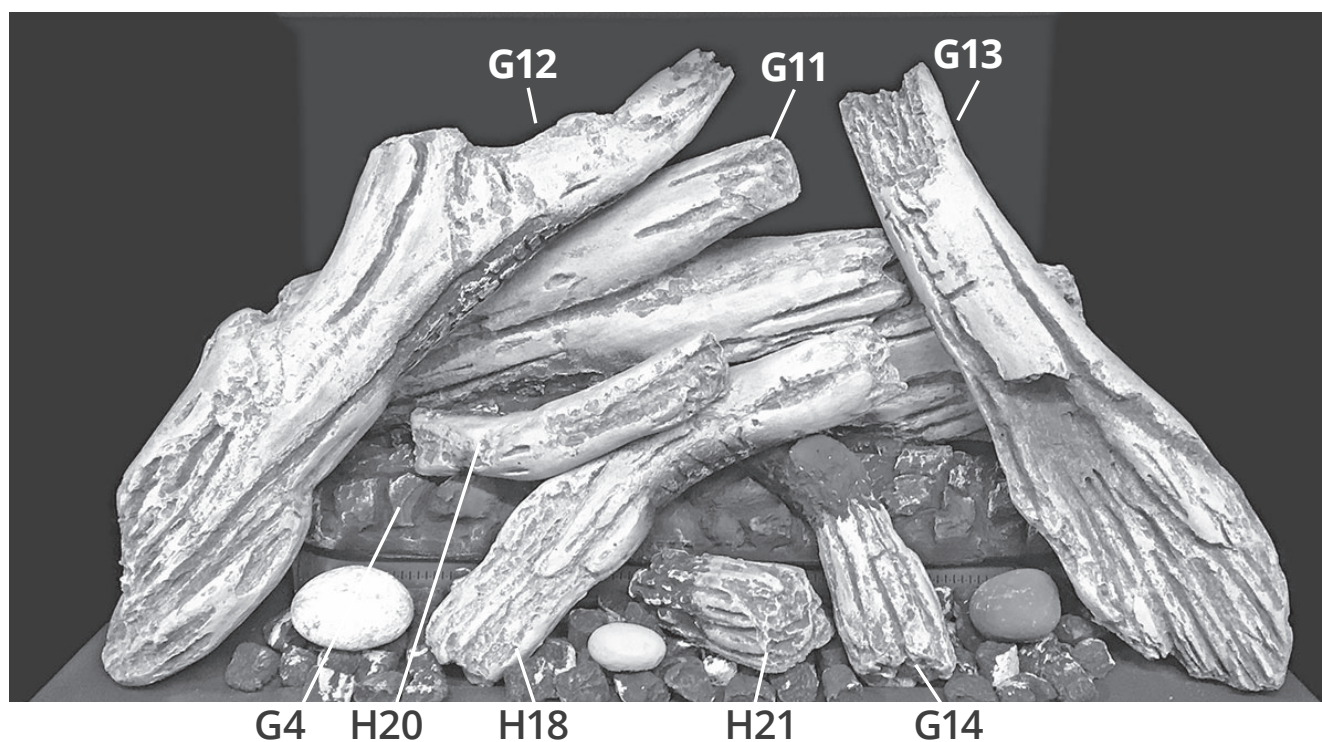

Installation

Window Re-Installation & Checking

Refit and Check Window

1. Place the window in its bottom railing and push its top against the firebox. **Ensure to remove any particles in the railing before installing the window.**

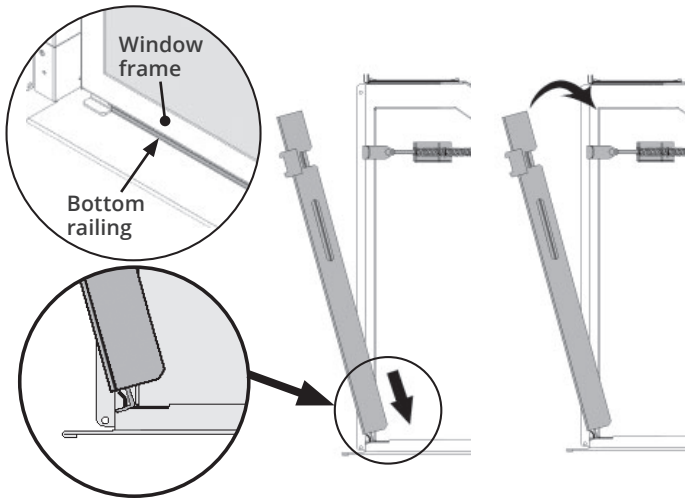

2. While you hold it, hook the side levers into the window tabs.

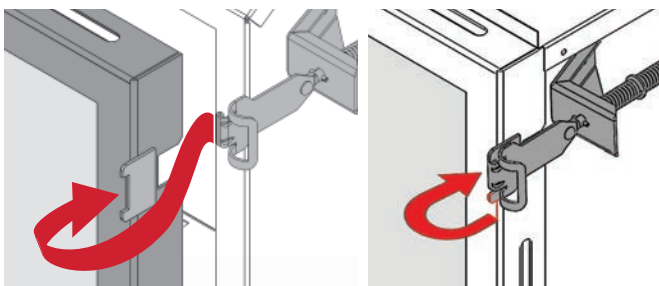

3. Pull out the top of the window and release it to ensure the springs return it.
4. Apply firm hand pressure around the window frame to ensure the window is sealed tight against the firebox.
5. If the Hot Glass Warning plate has been removed from the front lower corner of the window, reinstall it by sliding it between the glass and the frame as indicated below.

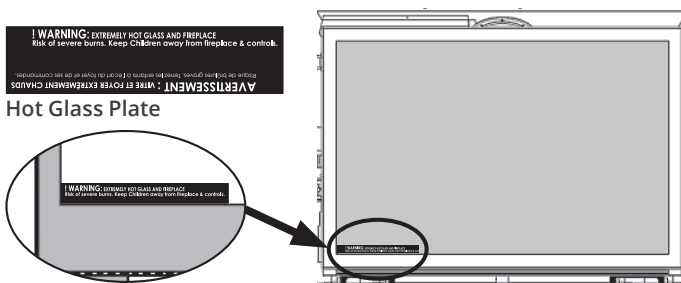

WARNING

The window unit must be correctly installed, fastened and sealed after servicing or serious bodily injury and/or damage to the appliance may result.

To ensure a safe operation:

- Double-check that the bottom of the window frame is correctly installed in the bottom support railing;
- Verify that the levers are hooked properly to the window tabs then;
- Pull out the top of the window and release it to ensure the springs return it;
- Ensure the window is sealed before operation.

WARNING

Failure to install the window correctly can:

- Leak carbon monoxide.
- Affect the performance of the fireplace.
- Damage components.
- Cause overheating resulting in dangerous conditions.

Damage caused by incorrect window installation is not covered by the Valor Warranty.

Installation

Synchronize Remote Control

The remote control system's receiver and handset must be initially synchronized before the first use.

1. Remove the battery holder cover (1 screw).
Insert 4 x AA 1.5V alkaline batteries in the holder.



2. On the left hand side of the firebox, pull the loose wire that is already connected to the receiver and connect it to the battery holder.

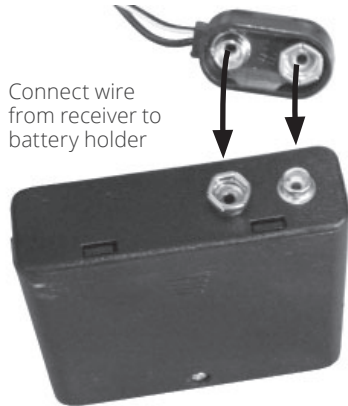

3. Insert 2 x AAA 1.5 V alkaline battery in the handset.
4. Locate the RESET button on the receiver.
5. With a sharp object, press and hold the receiver's RESET button until you hear one short and one long beep. Release the reset button after the second beep.

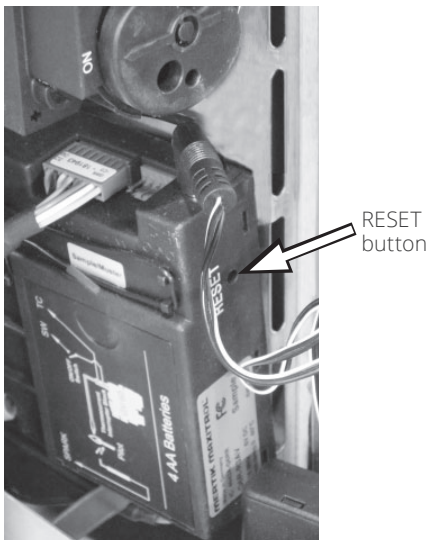

Remote Control Pairing

6. Within the subsequent 20 seconds, press and hold the  button on the remote handset for 2-3 seconds. **COM** will be displayed and flash on the handset during the pairing sequence. The handset will count up from 1 to 8, and you will hear two short beeps confirming the pairing is done.

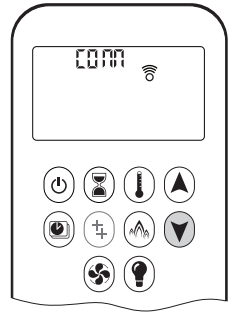

If you hear one long beep, the pairing sequence has failed or the wiring is incorrect.

This is a one time setting only and is not required when changing the batteries in the remote handset. The remote control system is now ready to use.

7. Inside the left panel of the appliance outer case, in front of the receiver, peel off the *Velcro* backing and stick the battery box on it to keep it in place.

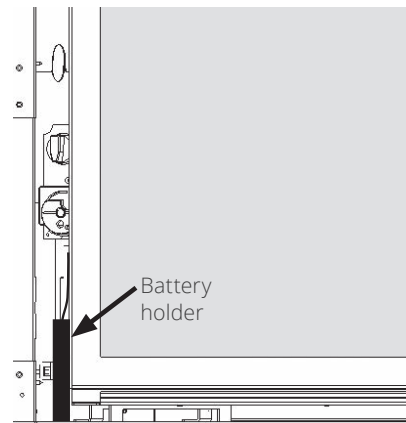

Installation

Check Operation

Turn the fireplace flame up and down using the remote control to confirm that the full range of inputs is achieved—see *Appendix B—Remote Control Operation* on page 40.

Adjust Aeration (if necessary)

Light the fire and allow the unit to warm up for 10–15 minutes to evaluate the flame picture. Burners are equipped with an adjustable shutter to control primary aeration. See the figures below. The shutters are factory-set to an aeration gap which will give optimum performance for the vast majority of installations.

Depending of fuel bed used, altitude and other considerations, the flame picture may be improved by adjusting the aeration. The need for adjustment should be determined only by operating the appliance with the fuel bed, liners and window installed and evaluating the flame picture after a 15-minute warm-up.

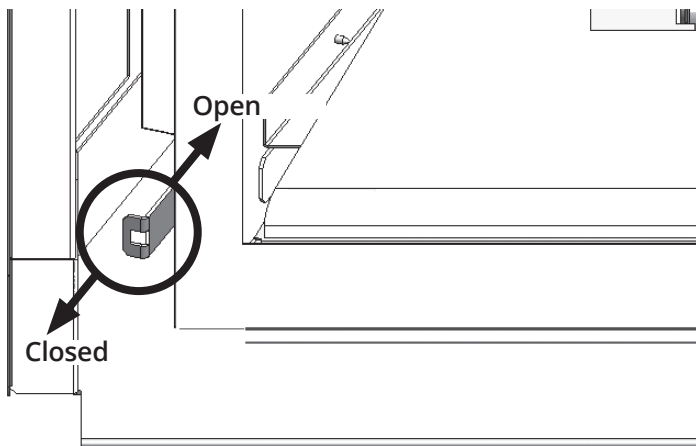
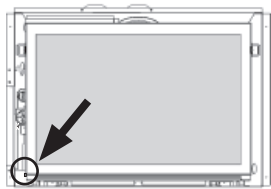

Pull or push the aeration lever at the bottom front left corner of the unit to close or open the air shutter. The shutter is visible at the left hand end of the burner.

Check Operation and Aeration

Increasing aeration (open) will cause the flames to appear more transparent and blue showing more ceramic effects glow.

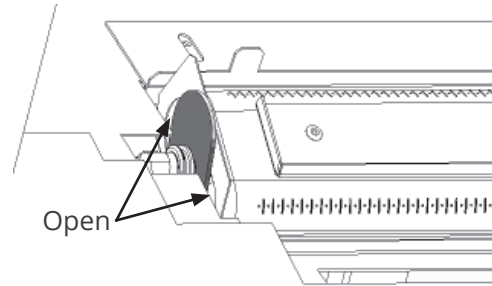

Decreasing aeration (close) will cause the flames to appear more yellow or orange showing less ceramic effects glow.

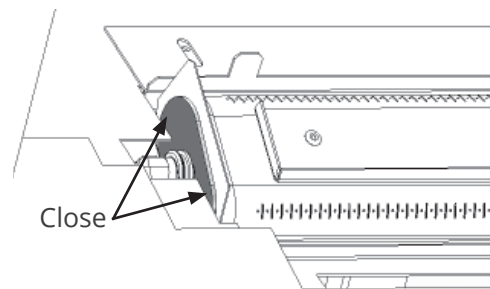

Too little aeration may result in black carbon forming on the logs or roof panel and dropping into the firebox. May also result in carbon or soot stains on the vent termination and exterior wall around the termination! The Manufacturer is not responsible for any damage caused by an air shutter setting with too little aeration.

Installation

Front Trim

Install Side Shrouds

The side shrouds are required to install the front on the appliance. They are supplied with the engine.

Fit them to the appliance outer case as indicated (2 screws/side).

See instructions supplied with the front trim for installation of trim.

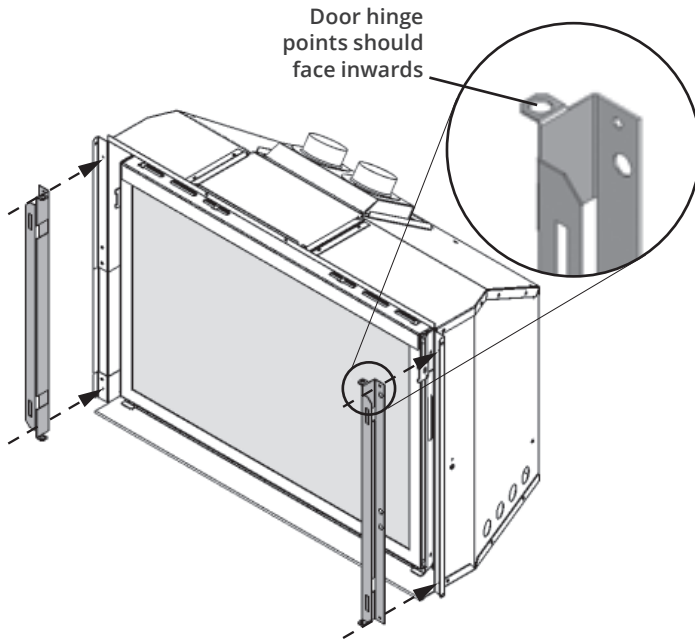

Install Front, Trim and Barrier Screen

Install the front or trim chosen by the customer for their fireplace. Install as well the barrier screen which is provided with the front or trim.

Show the customer how to access the controls when the front or trim are installed and how to remove them.

Follow the instructions provided with the front or trim and leave those instructions behind for the customer's further reference.

Installation

Remote Control Holder

Install Remote Control Handset Wall Holder

The remote control kit for this fireplace comes complete with a wall-mounted holder. This holder is not required in all installations but is provided as an optional feature for those customers who wish to mount the remote handset to the wall.



To install the holder to the wall, find a convenient location and use the hardware provided with the kit. Cover the screws with the included caps to finish the mounting.

Once mounted, the holder is magnetic - simply place the remote gently into the holder.

IMPORTANT: The location of the remote control handset is important to assure proper temperature regulation. To obtain a constant temperature, we recommend that the handset should be **between 3 and 15 feet away from the appliance but not directly above it.** We also advise that the handset should be located away from any other heat source and not in direct sunlight as this may affect the temperature sensor located in the remote handset.

Installation

GV60 Wiring Diagram

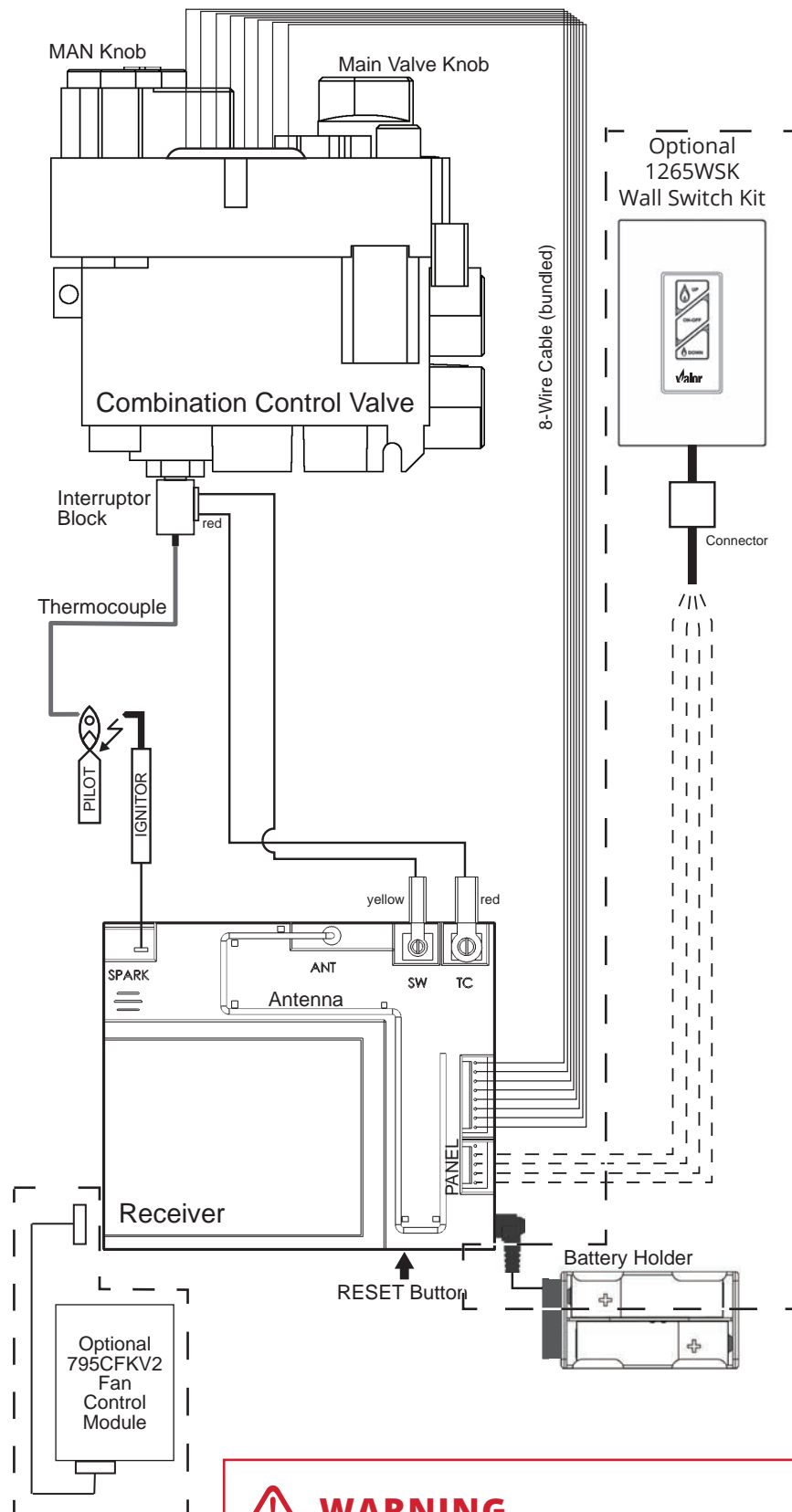

⚠ WARNING
NO ELECTRICAL CONNECTION ALLOWED
for any outdoor installation!

Commonwealth of Massachusetts

State of Massachusetts Carbon Monoxide Detector/Vent Terminal Signage Requirements

For all side wall horizontally vented gas fueled equipment installed in every dwelling, building or structure used in whole or in part for residential purposes, including those owned or operated by the Commonwealth and where the side wall exhaust vent termination is less than seven (7) feet above finished grade in the area of the venting, including but not limited to decks and porches, the following requirements shall be satisfied:

1. INSTALLATION OF CARBON MONOXIDE DETECTORS.

At the time of installation of the side wall horizontal vented gas fueled equipment, the installing plumber or gas fitter shall observe that a hard wired carbon monoxide detector with an alarm and battery back-up is installed on the floor level where the gas equipment is to be installed. In addition, the installing plumber or gas fitter shall observe that a battery operated or hard wired carbon monoxide detector with an alarm is installed on each additional level of the dwelling, building or structure served by the side wall horizontal vented gas fueled equipment. It shall be the responsibility of the property owner to secure the services of qualified licensed professionals for the installation of hard wired carbon monoxide detectors.

a. In the event that the side wall horizontally vented gas fueled equipment is installed in a crawl space or an attic, the hard wired carbon monoxide detector with alarm and battery back-up may be installed on the next adjacent floor level.

b. In the event that the requirements of this subdivision can not be met at the time of completion of installation, the owner shall have a period of thirty (30) days to comply with the above requirements; provided, however, that during said thirty (30) day period, a battery operated carbon monoxide detector with an alarm shall be installed.

2. APPROVED CARBON MONOXIDE DETECTORS. Each carbon monoxide detector as required in accordance with the above provisions shall comply with NFPA 720 and be ANSI/UL 2034 listed and IAS certified.

3. SIGNAGE. A metal or plastic identification plate shall be permanently mounted to the exterior of the building at a minimum height of eight (8) feet above grade directly in line with the exhaust vent terminal for the horizontally vented gas fueled heating appliance or equipment. The sign shall read, in print size no less than one-half (1/2) inch in size, "GAS VENT DIRECTLY BELOW. KEEP CLEAR OF ALL OBSTRUCTIONS".

4. INSPECTION. The state or local gas inspector of the side wall horizontally vented gas fueled equipment shall not approve the installation unless, upon inspection, the inspector observes carbon monoxide detectors and signage installed in accordance with the provisions of 248 CMR 5.08(2)(a)1 through 4.

(b) EXEMPTIONS: The following equipment is exempt from 248 CMR 5.08(2)(a)1 through 4:

1. The equipment listed in Chapter 10 entitled "Equipment Not Required To Be Vented" in the most current edition of NFPA 54 as adopted by the Board; and

2. Product Approved side wall horizontally vented gas fueled equipment installed in a room or structure separate from the dwelling, building or structure used in whole or in part for residential purposes.

(c) MANUFACTURER REQUIREMENTS - GAS EQUIPMENT VENTING SYSTEM PROVIDED. When the manufacturer of Product Approved side wall horizontally vented gas equipment provides a venting system design or venting system components with the equipment, the instructions provided by the manufacturer for installation of the equipment and the venting system shall include:

1. Detailed instructions for the installation of the venting system design or the venting system components; and

2. A complete parts list for the venting system design or venting system.

(d) MANUFACTURER REQUIREMENTS - GAS EQUIPMENT VENTING SYSTEM NOT PROVIDED.

When the manufacturer of a Product Approved side wall horizontally vented gas fueled equipment does not provide the parts for venting the flue gases, but identifies "special venting systems", the following requirements shall be satisfied by the manufacturer:

1. The referenced "special venting system" instructions shall be included with the appliance or equipment installation instructions; and

2. The "special venting systems" shall be Product Approved by the Board, and the instructions for that system shall include a parts list and detailed installation instructions.

(e) A copy of all installation instructions for all Product Approved side wall horizontally vented gas fueled equipment, all venting instructions, all parts lists for venting instructions, and/or all venting design instructions shall remain with the appliance or equipment at the completion of the installation.

Appendix A—Lighting Instructions

FOR YOUR SAFETY, READ BEFORE LIGHTING

WARNING: If you do not follow these instructions exactly a fire or explosion may result causing property damage, personal injury or loss of life.

- A. This appliance has a pilot which must be lighted by hand or by remote control. Follow these instructions exactly. To save gas, turn the pilot off when not using the appliance for a prolonged period of time.
- B. **BEFORE LIGHTING**, smell all around the appliance area for gas. Be sure to smell next to the floor because some gas are heavier than air and will settle on the floor.
- WHAT TO DO IF YOU SMELL GAS**
- Do not try to light any appliance.
 - Do not touch any electric switch; do not use any phone in your building.
 - Immediately call your gas supplier from a neighbor's phone. Follow the gas supplier's instructions.
 - If you cannot reach your gas supplier, call the fire department.
- C. Do not use this appliance if any part has been under water. Immediately call a qualified service technician to inspect the appliance and to replace any part of the control system and any gas control, which has been under water.
- D. Use only your hand to push in or turn the control knobs. Never use tools. If the knobs will not push in or turn by hand, don't try to repair them; call a qualified service technician. Force or attempted repair may result in a fire or explosion.

OPERATING INSTRUCTIONS

1. **STOP!** Read the safety information above.
2. This appliance is equipped with an on-demand pilot that shuts off after 7 days of inactivity.
3. **TO CLEAR ANY GAS**, turn main valve off by momentarily pressing OFF button (●) (1a) or (⏻) button (1b) on remote control handset.
 - Wait five (5) minutes to clear out any gas, then smell for gas, including near the floor. If you smell gas, **STOP!** Follow "B" in the safety information above on this label. If you don't smell gas, go to the next step.
4. **AUTOMATIC IGNITION: MAN-knob in ON position** (Fig. 2, A). (Ensure gas control knob is set to OFF (full clockwise ⤵) (Fig. 2, B). Locate the pilot inside firebox (Fig. 4).
 - On the remote control handset, press and hold simultaneously the OFF (●) and large flame (🔥) buttons (1a) OR, press and hold (⏻) button (1b); a short acoustic signal confirms the start has begun.
 - Further short acoustic signals indicate the ignition process is in progress.
 - When the pilot is lit, the gas control knob (Fig. 2, B) will automatically rotate to the highest setting. Press the small flame button (🔥) (1a) or down arrow (⏴) (1b) on the remote to reduce flames.
5. **MANUAL IGNITION: MAN-knob in MAN position** (Fig. 3, A).
 - With the window off, locate the pilot inside firebox (Fig. 4).
 - Set gas control knob to OFF (full clockwise ⤵) (Fig. 3, B).
 - Push down the manual pilot plunger with a small screwdriver or similar instrument (Fig. 3, C); this will establish the pilot gas flow.
 - Light gas at the pilot with a match (Fig. 4, 5).
 - Continue holding down manual pilot plunger for about 10 seconds (Fig. 3, C); after release, pilot should remain lit.
 - If the pilot will not stay lit after several tries, turn the gas control knob to OFF (full clockwise ⤵) (Fig. 3, B) and call your local service technician or gas supplier.
 - Once the pilot is lit, reinstall the window and set the MAN-knob to ON (full counter-clockwise ⤴) (Fig. 2, A); turn gas control knob up (⤴) or down (⤵) manually (Fig. 2, B) or use the flame buttons (🔥) (🔥) (1a) or arrow buttons (⏴) (⏴) (1b) on the remote control handset to adjust the flame height.

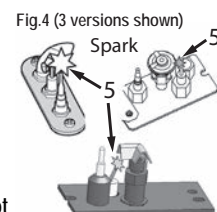
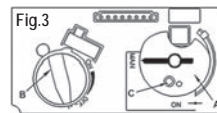
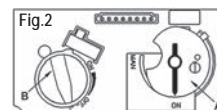
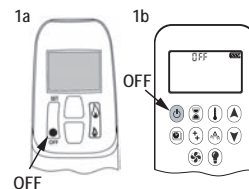

TO TURN OFF GAS TO APPLIANCE

AUTOMATIC SHUT-OFF (using the remote control handset):

Press and hold the small 🔥 button (1a) or ⏴ button (1b) to shut-off the main burner gas flow.

Momentarily press the "OFF" ● button (1a) or (⏻) button (1b) on remote handset to shut-off the appliance, including pilot flame.

DO NOT REMOVE FROM FIREPLACE

4009565-01

Appendix B—Remote Control Operation

Initial Pairing

Before the remote control can be used with the fireplace, it must be paired. See page 33.

Main Display and Remote Handset

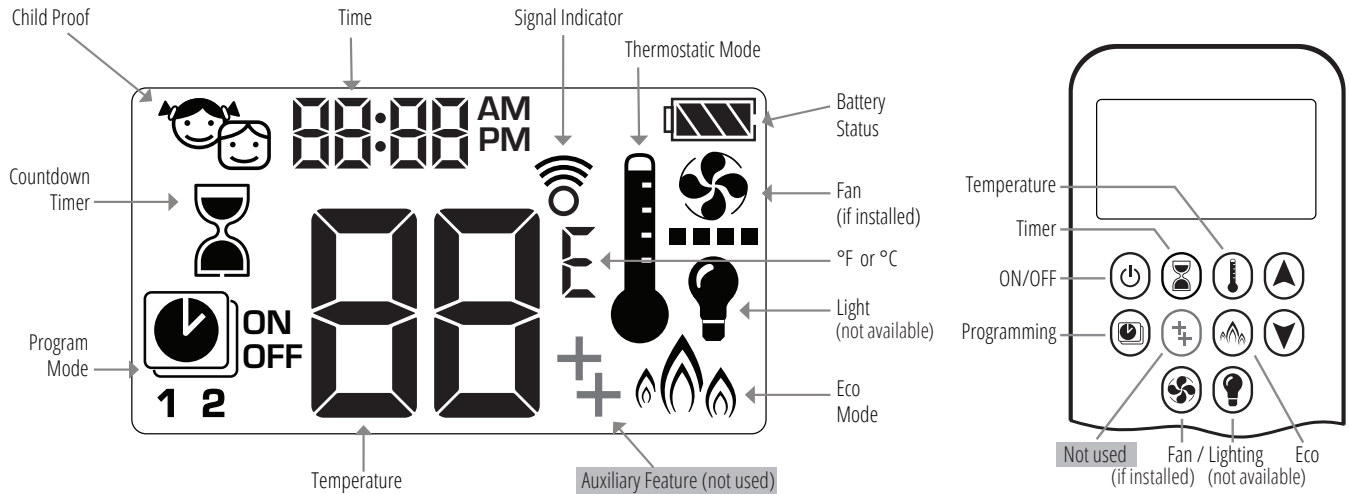

To Turn On Fire

NOTE: When pilot ignition is confirmed, motor automatically turns to maximum flame height.

One-Button lighting (default):

Two-Button lighting: + simultaneously

Press and hold for 4 seconds, until 8 short beeps and a blinking series of lines confirms the start sequence has begun. Release button.

Main gas flows once pilot ignition is confirmed.

Handset automatically goes into manual mode after main burner ignition.

Standby Mode (Pilot Flame)

Press and hold to set appliance to pilot flame.

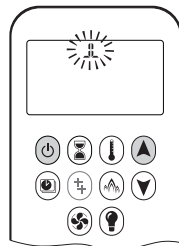
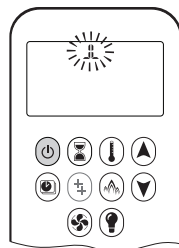

CAUTION: If the pilot does not stay lit after several tries call your local service technician or gas supplier.

To Turn Off Fire

Press to turn OFF.

Note: There is a 2 minute delay after switching off before the next ignition is possible.



CAUTION: Always check the fire and pilot visually to ensure they are off.

Flame Height Adjustment

To increase flame height, press and hold .

To decrease flame height, press and hold . You may hold the button down until the fire is set to pilot flame only.

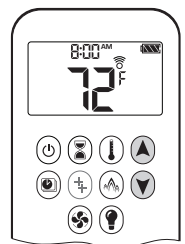



Appendix B—Remote Control Operation

Designated Low Fire and High Fire

To go to low fire, double-click . "LO" is displayed.

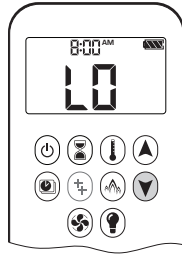
Note: Flame goes to high fire first before going to low fire.



To go to high fire, double-click . "HI" is displayed.

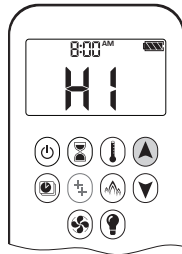

Choosing 1-Button or 2-Button Ignition

On the remote control handset, you can choose a 1-button or 2-button ignition. You can also choose to activate or deactivate some of the functions. By default, the handset is set to a 1-button ignition.



To change from 1-button to 2-button ignition, remove the batteries, wait 10 seconds, reinsert batteries, and immediately when the display flashes, press and hold the  button for 10 seconds. **ON** is displayed and **1** is flashing. When change is complete, **1** changes to **2**.

To change from 2-button to 1-button ignition, proceed the same as above. **ON** is displayed and **2** is flashing. When change is complete, **2** changes to **1**.

Deactivating or Activating Functions

These functions are active by default, but can be deactivated at any time:

- Child Proof
- Program Mode
- Thermostatic Mode
- Eco Mode
- Circulating Fan Operation
- Countdown Timer

 **NOTE:** The function Auxiliary Feature  is not used.

To deactivate functions:



1. Install batteries. All icons are displayed and flashing.
2. While the icons are flashing, press the relevant function button and hold for 10 seconds.
3. The function icon will flash until deactivation is complete. Deactivation is complete when the function icon and two horizontal bars () are displayed.

Note: If a deactivated button is pressed, there is no function, and the two horizontal bars are displayed.

To activate functions:

1. Install batteries. All icons are displayed and flashing.
2. While the icons are flashing, press the relevant function button and hold for 10 seconds.
3. The function icon will continue to flash until activation is complete, and then turn solid. Activation is complete when the function icon is displayed.















Setting Celsius or Fahrenheit

To change between °C and °F, press and hold  +  simultaneously.

Note : °C = 24-hour clock
°F = 12-hour clock



Setting the Time

1. Press  +  simultaneously. **Day** flashes.
2. Press  +  to select a number to correspond with the day of the week.
 - 1 = Monday
 - 2 = Tuesday
 - 3 = Wednesday
 - 4 = Thursday
 - 5 = Friday
 - 6 = Saturday
 - 7 = Sunday
3. Press  +  simultaneously. **Hour** flashes.
4. To select hour press  or .
5. Press  +  simultaneously. **Minutes** flash.
6. To select minutes press  or .
7. To confirm, press  +  simultaneously or wait.

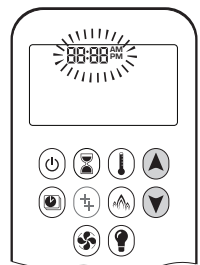

Appendix B—Remote Control Operation



Child Proof

Your handset can be set to lock out all commands to the fireplace, except OFF.

To turn Child Proof ON:

1. Press and hold  +  simultaneously.
2.  is displayed. Child Proof is now active.









To turn Child Proof OFF:

1. Press and hold  +  simultaneously.
2.  disappears. Child Proof is now inactive, and the handset has full function.

Countdown Timer

You can set your fireplace to automatically turn off at the end of a timer.

To set a Countdown Timer:

1. Press and hold  until  is displayed.
Hour flashes.
2. Press  or  to select Hour.
3. To confirm, press .
- Minutes** flash.
4. Press  or  to select Minutes.
5. To confirm, press  or wait.

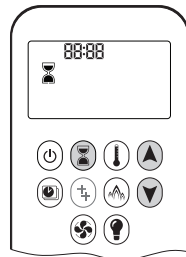

To turn off a Countdown Timer:







1. Press , and the  countdown disappears.

Note: The Countdown Timer only works in Manual, Thermostatic, and Eco modes. Maximum countdown time is 9 hours and 50 minutes.

Light/Dimmer Operation (not available)

Circulating Fan Operation (if installed)

Setting:

1. Press and hold  until  flashes.
2. Press  to increase or  to decrease fan speed.
3. To confirm setting, either press  or wait.  is displayed.

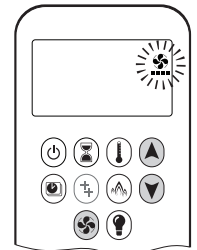

Off:

Press  until all 4 speed level bars disappear.

Note: When setting, if the fan was not switched off after last use, it starts automatically 4 minutes after ignition at maximum speed, and goes to the last set level after 10 seconds. The fan stops 10 minutes after the gas is OFF or at pilot.

Appendix B—Remote Control Operation

Modes of Operation

Thermostatic Mode

The room temperature is measured and compared to the set temperature. The flame height is automatically adjusted to achieve the set temperature.

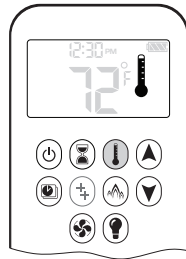

Program Mode

The temperature is controlled by Programs 1 and 2, each of which can be set to go on and off at specific times, at a set temperature.



Eco Mode

Flame height modulates between high and low. If the room temperature is lower than the set temperature, the flame height stays on high for a longer period of time. If the room temperature is higher than the set temperature, the flame height stays on low for a longer period of time. One cycle lasts approximately 20 minutes.





 If any of the above modes (Thermostatic, Program, or Eco) are engaged by the MyFire app over WiFi, the handset will display **APP**.

Manual Mode

The on/off status of the fireplace, as well as flame height, are manually controlled by the user.





Thermostatic Mode

On:

Press .  is displayed. Preset temperature displays briefly, followed by the room temperature.





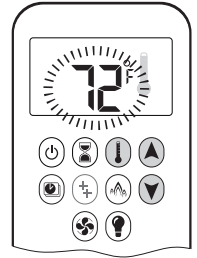

Setting Desired Temperature:

1. Press and hold  until  is displayed and set temperature flashes.
2. To adjust set temperature, press  or .
3. To confirm, press  or wait.



Off:

1. Press .
2. Press  or  to go to Manual Mode.
3. Press  to go to Program Mode.
4. Press  to go to Eco Mode.





Program Mode

On:

Press .
, 1 or 2, ON or OFF are displayed.



Off:

1. Press , , or  to go to Manual Mode.
2. Press  to go to Thermostatic Mode.
3. Press  to go to Eco Mode.

Note: The set temperature for Thermostatic Mode is the temperature for the ON time in Program Mode. Changing the Thermostatic Mode set temperature also changes the ON time temperature in Program Mode.

Default Settings:

- ON TIME (Thermostatic) TEMPERATURE: 70°F / 21°C
- OFF TIME TEMPERATURE: "— —" (pilot flame only)

Appendix B—Remote Control Operation

Temperature Setting:

1. Press and hold until flashes. **ON** and set temperature (set in Thermostatic Mode) is displayed.
2. To continue, press or wait. **OFF** displayed, temperature flashes.
3. Select off temperature by pressing or .
4. To confirm, press .

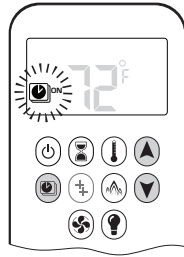

Note: The on (Thermostatic) and off set temperatures are the same for each day.

Day Setting:

1. **ALL** flashes. Press or to choose between:
 - **ALL** = same settings ON-OFF every day
 - **SA:SU** = same settings ON-OFF Saturday and Sunday
 - **1, 2, 3, 4, 5, 6, 7** = daily timer—unique ON-OFF settings for a single day of the week, for multiple days of the week or for every day of the week.
2. To confirm, press .

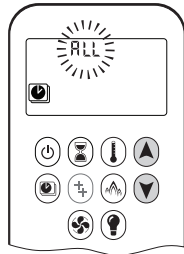

ALL Selected (same settings every day)

On Time Setting (PROGRAM 1)

1. **1, ON** are displayed. **ALL** is displayed briefly. Hour flashes.
2. To select hour, press or .
3. To confirm, press . **1, ON** are displayed. **ALL** displayed briefly. Minutes flash.
4. To select minutes, press or .
5. To confirm, press .

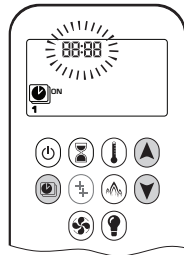

Off Time Setting (PROGRAM 1)

1. **1, OFF** are displayed. **ALL** is displayed briefly. Hour flashes.
2. To select hour, press or .
3. To confirm, press . **1, OFF** are displayed. **ALL** displayed briefly. Minutes flash.
4. To select minutes, press or .
5. To confirm, press .

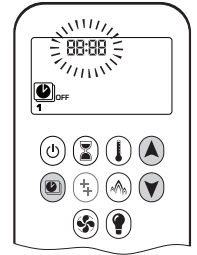

Note: Either continue to PROGRAM 2 and set ON and OFF times or stop programming at this point, and PROGRAM 2 remains deactivated.

Note: PROGRAM 1 and 2 use the same ON (Thermostatic) and OFF temperatures. Once a new ON (Thermostatic) and/or OFF temperature has been set, that temperature becomes the new default setting.

Note: ON and OFF times programmed for PROGRAM 1 and PROGRAM 2 become the new default times.

The batteries must be removed to clear the PROGRAM 1 and PROGRAM 2 ON and OFF times and temperatures.

SA:SU (same settings Saturday and Sunday) or 1, 2, 3, 4, 5, 6, 7 (different settings on different days)

- Set on time and off time using the same procedure as “ALL Selected” above.
- Waiting to finish setting.

Eco Mode

On:

Press button to enter Eco Mode. is displayed.

Flame height modulates between high and low every 20 minutes.

Off:

Press button to exit Eco Mode. disappears.



Appendix B—Remote Control Operation

Low Battery Indication

⚠ CAUTION: Do not use a screwdriver or other metallic object to remove the batteries from the battery holder or the handset. This could cause a short circuit.

Handset

The battery icon  will show when the battery needs to be replaced. Replace with two 1.5 V AAA alkaline batteries.

Receiver

Frequent beeps for 3 seconds when the motor turns indicate the batteries in the battery holder need to be replaced. Replace with four 1.5 V AA alkaline batteries.

Automatic Shut Off

Countdown Timer

At the end of countdown time period, the fire turns off. The Countdown Timer only works in Manual, Thermostatic, and Eco Modes. Maximum countdown time is 9 hours and 50 minutes.

Low Battery Receiver

With low battery power in the battery holder, the system shuts off the fire completely. (This will not happen if the power is completely interrupted.)

Seven Day Shut Off

The system shuts off the fire completely if there is no change in flame height for 7 days.

Automatic Turn Down



3 Hour No Communication Function

The valve will turn to pilot flame if there is no communication between the handset and receiver for a 3-hour period. The fire will continue to function normally when communication is restored.

Appendix B—Remote Control Operation

Error Codes

In the event of an error condition with the handset or fireplace, the handset will display an error code.

Failure Code	Message on Handset	Duration of Display	Symptom	Possible Cause
F04	F04	4 sec	<ul style="list-style-type: none"> No pilot flame within 30 sec Note: after 3 failed ignition sequences, F06 shown 	<ul style="list-style-type: none"> No gas supply Air in pilot supply line No spark Reversed polarity in thermocouple wiring
F06	F06	4 sec	<ul style="list-style-type: none"> 3 failed ignition sequences in 5 minutes Fire is not responding, no pilot flame 	<ul style="list-style-type: none"> No gas supply Air in pilot supply line No spark Reversed polarity in thermocouple wiring Incorrect pilot orifice if valve has been converted from LPG to NG or vice versa
F07	Low battery symbol 	Permanent	<ul style="list-style-type: none"> Battery icon flashes on handset display 	<ul style="list-style-type: none"> Low battery in handset
F09	F09	4 sec	<ul style="list-style-type: none"> Fire is not responding No electronic control of fire 	<ul style="list-style-type: none"> Down arrow button  was not pressed during pairing Receiver and handset are not synced
F46	F46	4 sec	<ul style="list-style-type: none"> Fire is not responding Intermittent response No electronic control of fire 	<ul style="list-style-type: none"> No or bad connection between receiver and handset No power at receiver (batteries low) Low communication range (mains adapter faulty, handset not communicating with receiver)

Appendix C—Spare Parts

	Description	Part No.
1	VDRT slider assembly (AutoFire)	4006540
2	Exhaust plate gasket	4001662
3	Shroud (2)	4003295AZ
4	Burner cover platform	4007921AH
4a	Cover panel, for Driftwood kit	4007895
5	Log support bracket	4008289
6	Side cover	4002806
7	Valve access plate	4002510
8	Access plate gasket	4002664
9	Window assembly	4004409S
10	Explosion lever assembly (right hand)	4003680
11	Explosion level assembly (left hand)	4003681
12	Hot glass warning plate	4003093
13	Battery holder cable (1500 mm)	4006552
14	Battery holder	4008039
15	Valor10 handset, black	4007548
16	Valor10 wall holder	4004459
17	GV60 valve repair kit (not included)	4004544
18	Burner module assembly (natural gas)	4012593S
	Burner module assembly (propane gas)	4012594S
19	Pilot shield	4008555AH
20	Pilot assembly (natural gas)	4006019S
	Pilot assembly (propane gas)	4006020S
23	Thermocouple	4004801
24	Pilot injector #51 (natural gas)	4000735
	Pilot injector #30 (propane gas)	4000736
25	Pilot tube	4005046
26	Pilot hood 2-flame	4000730
27	Burner	4007354
28	Pilot bracket	4007142
29	Platform stand	4007799
30	Burner mount (2)	4007140
31	Platform fixing bracket	4008079
32	Flex pipe assembly with valve	4002475
33	Anti-flashback shield	4007629
34	Air shutter (Natural gas)	4007136
	Air shutter (Propane)	4008699
35	Spring tension washer	4007460
36	Steel flat washer	4007461
37	Injector elbow 82-750 (natural gas)	4000738
	Injector elbow 92-260 (propane)	9730007
38	Gas supply tube assembly	4007875
39	Thermocouple interruptor block	4001037
40	GV60 valve, no fittings	4000873
40a	Inlet connector	4000746

	Description	Part No.
40b	Inlet elbow	4007704
40c	Straight connector	220K891
40d	By-pass screw #175 (natural gas)	4007532
	By-pass screw #105 (propane gas)	4000824
41	Module side plate top gasket	4003238
42	Module side plate side gasket (2)	4002404
43	Module side plate bottom gasket	4003237
44	Symax receiver two-way	4005597
45	Pipe sealing plate	4012145A
46	Thermocouple sealing plate	4012145B
47	Wiring harness GV60	4001187
48	Ignition cable 900 mm	4004800
49	Ignition cable sleeve	4002244
50	Interruptor cable (red)	4001035
51	Interruptor cable (yellow)	4002096
52	Birch Log Kit	700BLK
	Birch Log G1	4008159
	Birch Log G2	4008160
	Birch Log G3	4008161
	Birch Log G4	4008162
	Birch Log G5	4008163
	Birch Log G6	4008164
	Birch Log H7	4007469
	Birch Log H9	4007471
	Birch Log H10	4007472
	Birch Log H11	4007473
53	Embers (2 cup bag)	4008304
54	Driftwood Log Kit	700DWK
	Driftwood Log G11	4008169
	Driftwood Log G12	4008170
	Driftwood Log G13	4008171
	Driftwood Log G4	4008162
	Driftwood Log G14	4008172
	Driftwood Log H18	4007497
	Driftwood Log H20	4007499
	Driftwood Log H21	4007500
	Driftwood Pebbles (set of 3)	4008173
	55	Embers (2 cup bag)
57	Traditional Log Kit	700LSK
	Traditional Log G4	4008162
	Traditional Log G7	4008165
	Traditional Log G8	4008166
	Traditional Log G9	4008167
	Traditional Log G10	4008168
	Traditional Log G16	4008306

Appendix C—Spare Parts

	Description	Part No.
	Traditional Log H10	4007472
	Traditional Log H11	4007473
	Traditional Log H28	4007505
	Traditional Log H31	4007508
58	Embers (2 cup bag)	4008304
59	Liner panels - complete set	
	Fluted Black Liner Kit	707FBL
	Ledgestone Liner Kit	705LSLV3
	Red Brick Liner Kit	708VRL
60	Left hand side panel	
	Fluted Black	4003208
	Ledgestone V3	4008184
	Red Brick	4003217
61	Right hand side panel	
	Fluted Black	4003209
	Ledgestone V3	4008185
	Red Brick	4003218
62	Rear panel	
	Fluted Black	4003210
	Ledgestone V3	4008183
	Red Brick	4003219
63	Top panel	
	Fluted Black	4003202
	Ledgestone V3	4008182
	Red Brick	4003220
64	Reflective Glass panels - complete set	706RGL
65	Left hand infill panel	4003466
66	Left hand glass panel	4004705
67	Right hand glass panel	4004706
68	Rear infill panel	4004804
69	Rear glass panel	4004704
70	Top liner panel	4003202
71	Side anchor	4004710AH
72	Side spacer (3)	4004711
73	2.5-4.5" hose clamp (2)	4000768

Appendix C—Spare Parts

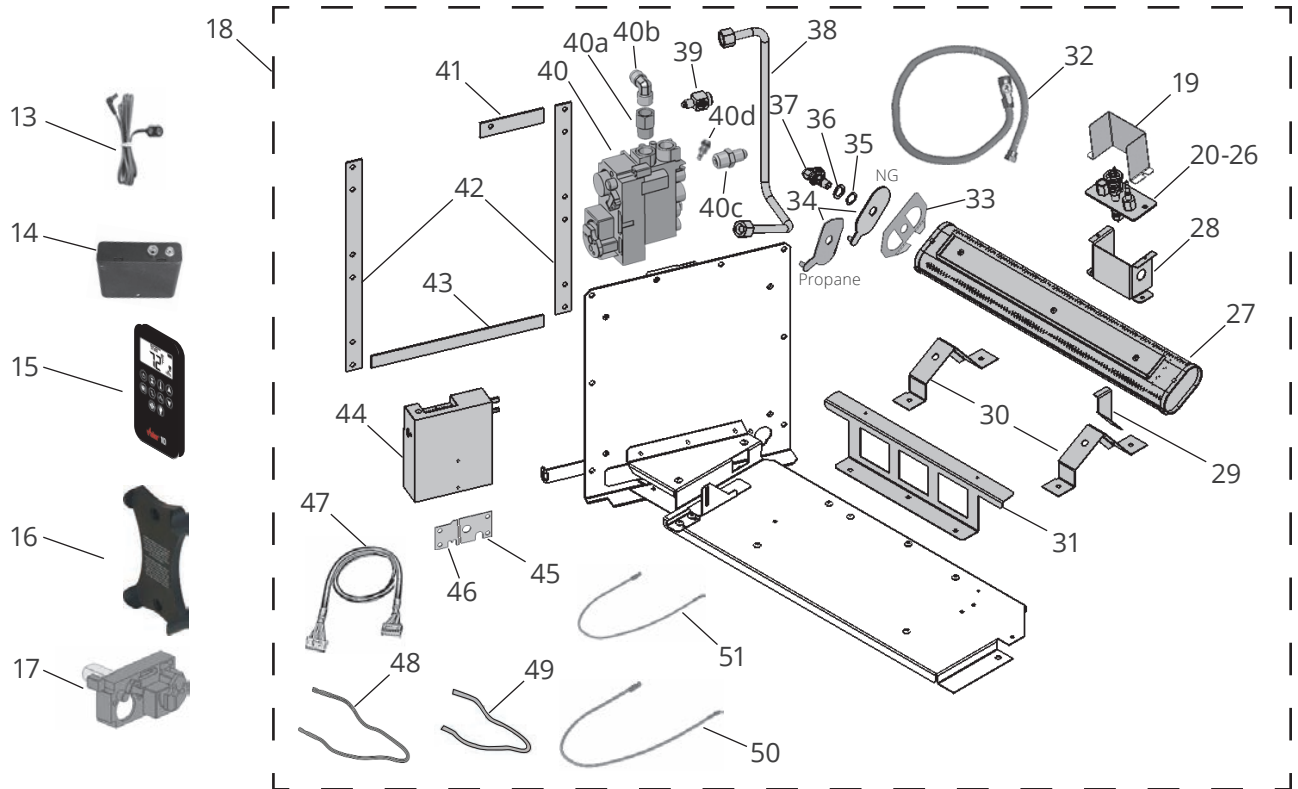
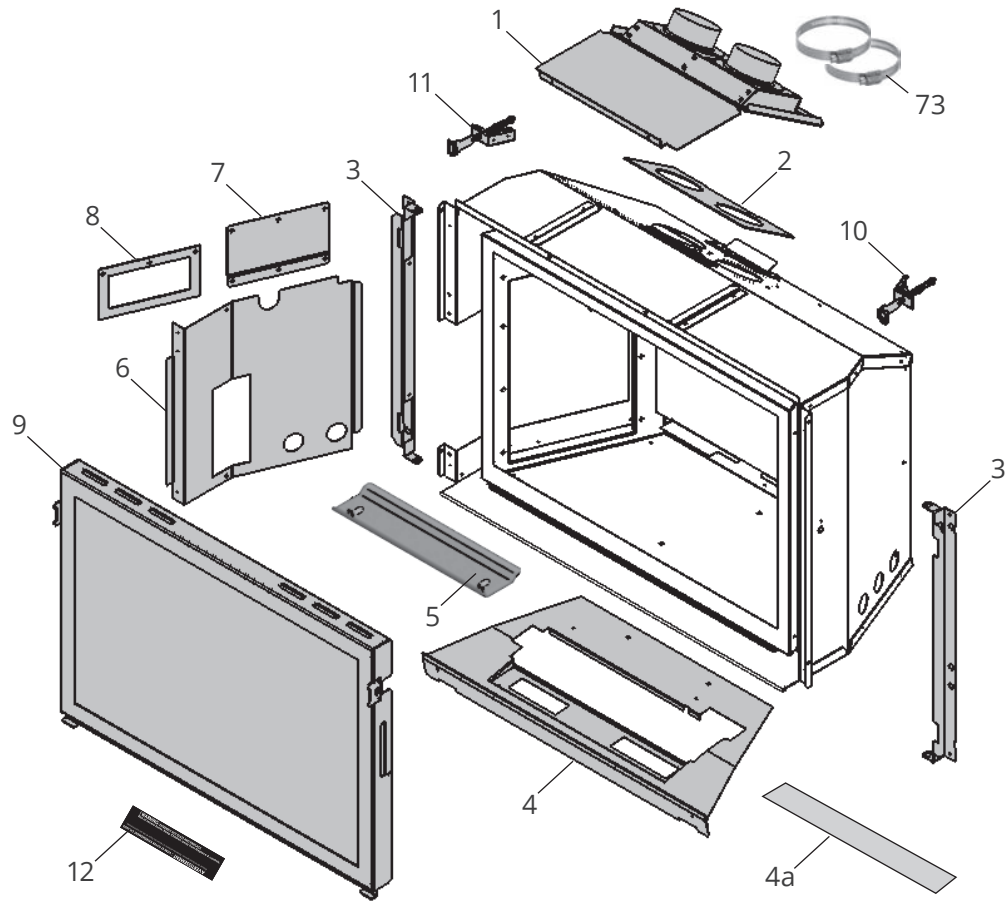

Appendix C—Spare Parts

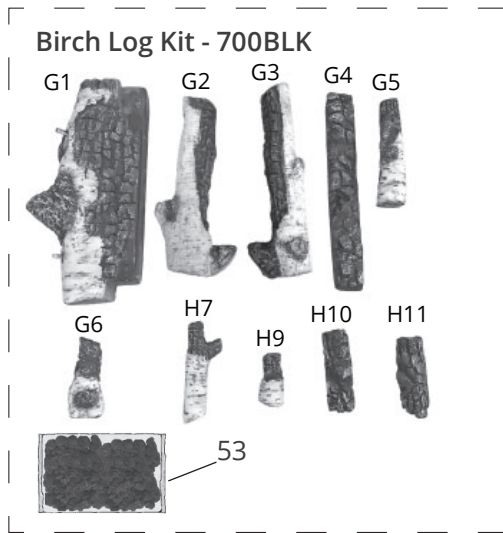

52

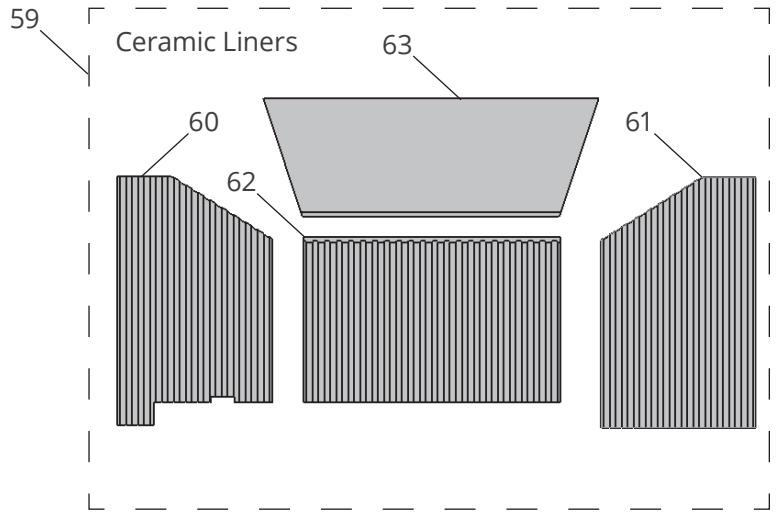

59

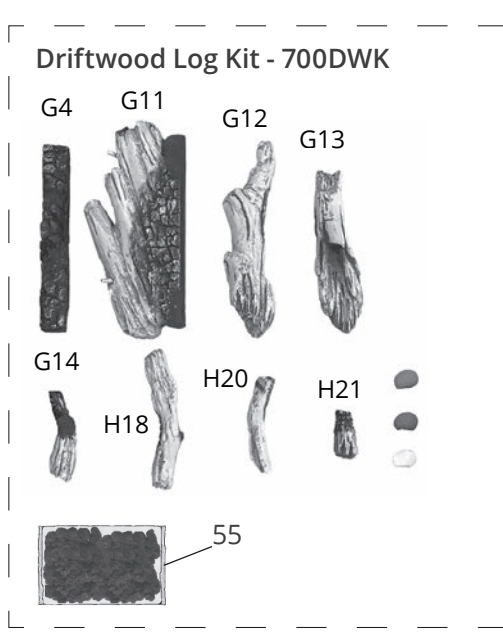

54

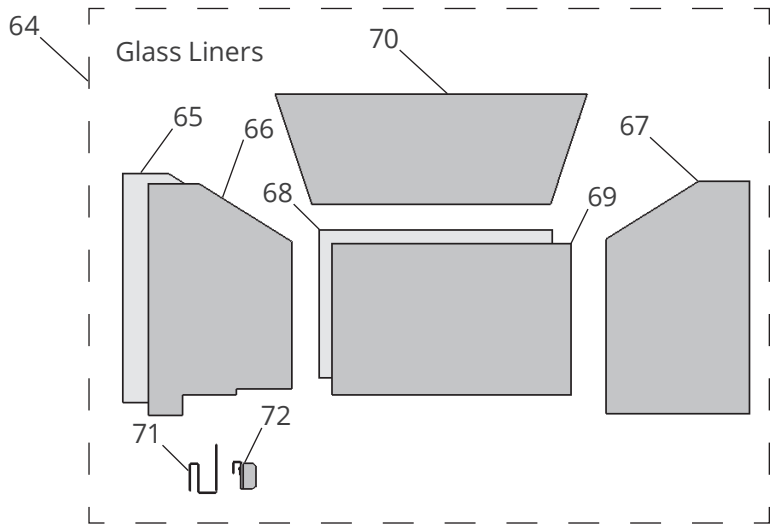

64

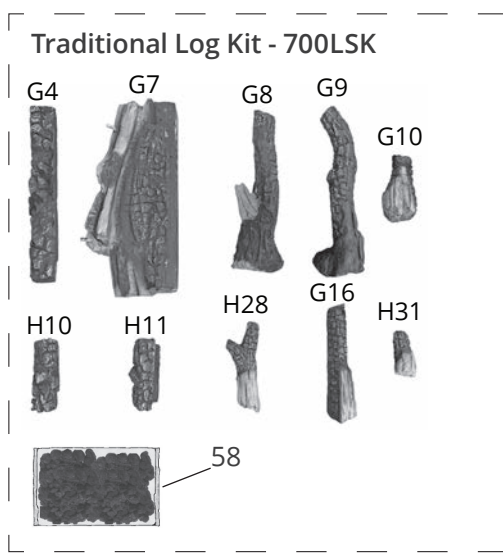

57